



Intel[®] Desktop Board D865PCD Technical Product Specification

April 2004

Order Number: C73314-001

The Intel[®] Desktop Board D865PCD may contain design defects or errors known as errata that may cause the product to deviate from published specifications. Current characterized errata are documented in the Intel Desktop Board D865PCD Specification Update.

Revision History

Revision	Revision History	Date
-001	First release of the Intel® Desktop Board D865PCD Technical Product Specification.	April 2004

This product specification applies to only standard Intel® Desktop Board D865PCD with BIOS identifier RC86510A.86A.

Changes to this specification will be published in the Intel Desktop Board D865PCD Specification Update before being incorporated into a revision of this document.

INFORMATION IN THIS DOCUMENT IS PROVIDED IN CONNECTION WITH INTEL® PRODUCTS. NO LICENSE, EXPRESS OR IMPLIED, BY ESTOPPEL OR OTHERWISE, TO ANY INTELLECTUAL PROPERTY RIGHTS IS GRANTED BY THIS DOCUMENT. EXCEPT AS PROVIDED IN INTEL'S TERMS AND CONDITIONS OF SALE FOR SUCH PRODUCTS, INTEL ASSUMES NO LIABILITY WHATSOEVER, AND INTEL DISCLAIMS ANY EXPRESS OR IMPLIED WARRANTY, RELATING TO SALE AND/OR USE OF INTEL PRODUCTS INCLUDING LIABILITY OR WARRANTIES RELATING TO FITNESS FOR A PARTICULAR PURPOSE, MERCHANTABILITY, OR INFRINGEMENT OF ANY PATENT, COPYRIGHT OR OTHER INTELLECTUAL PROPERTY RIGHT. INTEL PRODUCTS ARE NOT INTENDED FOR USE IN MEDICAL, LIFE SAVING, OR LIFE SUSTAINING APPLICATIONS.

Intel Corporation may have patents or pending patent applications, trademarks, copyrights, or other intellectual property rights that relate to the presented subject matter. The furnishing of documents and other materials and information does not provide any license, express or implied, by estoppel or otherwise, to any such patents, trademarks, copyrights, or other intellectual property rights.

Intel may make changes to specifications and product descriptions at any time, without notice.

Designers must not rely on the absence or characteristics of any features or instructions marked "reserved" or "undefined." Intel reserves these for future definition and shall have no responsibility whatsoever for conflicts or incompatibilities arising from future changes to them.

Intel® desktop boards may contain design defects or errors known as errata, which may cause the product to deviate from published specifications. Current characterized errata are available on request.

Contact your local Intel sales office or your distributor to obtain the latest specifications before placing your product order.

Copies of documents which have an ordering number and are referenced in this document, or other Intel literature, may be obtained from:

Intel Corporation
P.O. Box 5937
Denver, CO 80217-9808

or call in North America 1-800-548-4725, Europe 44-0-1793-431-155, France 44-0-1793-421-777,
Germany 44-0-1793-421-333, other Countries 708-296-9333.

Intel, Pentium, and Celeron are registered trademarks of Intel Corporation or its subsidiaries in the United States and other countries.

* Other names and brands may be claimed as the property of others.

Copyright© 2004, Intel Corporation. All Rights Reserved.

Preface

This Technical Product Specification (TPS) specifies the board layout, components, connectors, power and environmental requirements, and the BIOS for the Intel® Desktop Board D865PCD. It describes the standard product and available manufacturing options.

Intended Audience

The TPS is intended to provide detailed, technical information about the Desktop Board D865PCD and its components to the vendors, system integrators, and other engineers and technicians who need this level of information. It is specifically *not* intended for general audiences.

What This Document Contains

Chapter	Description
1	A description of the hardware used on the Desktop Board D865PCD
2	A map of the resources of the Desktop Board
3	The features supported by the BIOS Setup program
4	The contents of the BIOS Setup program's menus and submenus
5	A description of the BIOS error messages, beep codes, and POST codes

Typographical Conventions

This section contains information about the conventions used in this specification. Not all of these symbols and abbreviations appear in all specifications of this type.

Notes, Cautions, and Warnings

NOTE

Notes call attention to important information.

INTEGRATOR'S NOTES

Integrator's notes are used to call attention to information that may be useful to system integrators.

CAUTION

Cautions are included to help you avoid damaging hardware or losing data.



WARNING

Warnings indicate conditions, which if not observed, can cause personal injury.

Other Common Notation

#	Used after a signal name to identify an active-low signal (such as USBP0#)
(NxnX)	When used in the description of a component, N indicates component type, xn are the relative coordinates of its location on the Desktop Board D865PCD, and X is the instance of the particular part at that general location. For example, J5J1 is a connector, located at 5J. It is the first connector in the 5J area.
GB	Gigabyte (1,073,741,824 bytes)
GB/sec	Gigabytes per second
KB	Kilobyte (1024 bytes)
Kbit	Kilobit (1024 bits)
kbits/sec	1000 bits per second
MB	Megabyte (1,048,576 bytes)
MB/sec	Megabytes per second
Mbit	Megabit (1,048,576 bits)
Mbit/sec	Megabits per second
xxh	An address or data value ending with a lowercase h indicates a hexadecimal value.
x.x V	Volts. Voltages are DC unless otherwise specified.
*	This symbol is used to indicate third-party brands and names that are the property of their respective owners.

Contents

1 Product Description

1.1	Overview	12
1.1.1	Feature Summary	12
1.1.2	Board Layout.....	13
1.1.3	Block Diagram.....	14
1.2	Online Support	15
1.3	Design Specifications	16
1.4	Processor	19
1.5	System Memory	20
1.5.1	Memory Configurations	22
1.6	Intel® 865P Chipset	24
1.6.1	Universal 0.8 V / 1.5 V AGP 3.0 Connector.....	24
1.6.2	USB.....	25
1.6.3	IDE Support	26
1.6.4	Real-Time Clock, CMOS SRAM, and Battery.....	26
1.7	I/O Controller.....	27
1.7.1	Serial Port	27
1.7.2	Parallel Port.....	27
1.7.3	Diskette Drive Controller	27
1.7.4	Keyboard and Mouse Interface	28
1.8	Audio Subsystem.....	28
1.8.1	Realtek ALC202-based Audio Subsystem.....	28
1.8.2	Audio Connectors.....	28
1.8.3	Audio Subsystem Software	29
1.9	LAN Subsystem.....	29
1.9.1	Intel® 82562EZ Physical Layer Interface Device	29
1.9.2	RJ-45 LAN Connector with Integrated LEDs	30
1.9.3	LAN Subsystem Software	30
1.10	Chassis Intrusion and Detection	30
1.11	Power Management	30
1.11.1	ACPI.....	31
1.11.2	Hardware Support.....	33

2 Technical Reference

2.1	Introduction.....	37
2.2	Memory Map	37
2.3	DMA Channels	38
2.4	Fixed I/O Map.....	38
2.5	PCI Configuration Space Map	39
2.6	Interrupts	40
2.7	PCI Interrupt Routing Map.....	41
2.8	Connectors	43
2.8.1	Back Panel Connectors.....	44

2.8.2	Internal I/O Connectors	45
2.8.3	External I/O Connectors	52
2.9	Jumper Blocks	56
2.9.1	Front Panel Audio Connector/Jumper Block.....	56
2.9.2	BIOS Setup Configuration Jumper Block.....	57
2.10	Mechanical Considerations.....	58
2.10.1	Form Factor	58
2.10.2	I/O Shield	59
2.11	Electrical Considerations	60
2.11.1	DC Loading	60
2.11.2	Add-in Board Considerations.....	60
2.11.3	Fan Connector Current Capability	60
2.11.4	Power Supply Considerations	61
2.12	Thermal Considerations.....	61
2.13	Reliability	63
2.14	Environmental	64
2.15	Regulatory Compliance	65
2.15.1	Safety Regulations	65
2.15.2	EMC Regulations	65
2.15.3	European Union Declaration of Conformity Statement	66
2.15.4	Product Ecology Statements	67
2.15.5	Product Certification Markings (Board Level)	67

3 Overview of BIOS Features

3.1	Introduction.....	69
3.2	BIOS Flash Memory Organization	69
3.3	Resource Configuration	70
3.3.1	PCI Autoconfiguration	70
3.3.2	PCI IDE Support.....	70
3.4	System Management BIOS (SMBIOS)	71
3.5	Legacy USB Support	71
3.6	BIOS Updates	72
3.6.1	Language Support.....	72
3.6.2	Custom Splash Screen.....	73
3.7	Recovering BIOS Data	73
3.8	Boot Options.....	74
3.8.1	CD-ROM Boot.....	74
3.8.2	Network Boot.....	74
3.8.3	Booting Without Attached Devices	74
3.8.4	Changing the Default Boot Device During POST.....	74
3.9	Fast Booting Systems with Intel® Rapid BIOS Boot.....	75
3.9.1	Peripheral Selection and Configuration	75
3.9.2	Intel Rapid BIOS Boot	75
3.10	BIOS Security Features	76

4 BIOS Setup Program

4.1	Introduction.....	77
4.2	Maintenance Menu	78
4.3	Main Menu.....	79
4.4	Advanced Menu.....	80
4.4.1	PCI Configuration Submenu.....	81
4.4.2	Boot Configuration Submenu	82
4.4.3	Peripheral Configuration Submenu.....	83
4.4.4	Drive Configuration Submenu	85
4.4.5	Floppy Configuration Submenu	88
4.4.6	Event Log Configuration Submenu.....	89
4.4.7	Video Configuration Submenu.....	90
4.4.8	USB Configuration Submenu	91
4.4.9	Chipset Configuration Submenu.....	92
4.5	Security Menu	94
4.6	Power Menu	95
4.6.1	ACPI Submenu	95
4.7	Boot Menu	96
4.7.1	Boot Device Priority Submenu.....	97
4.7.2	Hard Disk Drives Submenu	98
4.7.3	Removable Devices Submenu	98
4.7.4	ATAPI CD-ROM Drives Submenu.....	99
4.8	Exit Menu	99

5 Error Messages and Beep Codes

5.1	BIOS Error Messages.....	101
5.2	Port 80h POST Codes.....	103
5.3	Bus Initialization Checkpoints	107
5.4	Speaker	108
5.5	BIOS Beep Codes	108

Figures

1.	Desktop Board D865PCD Components.....	13
2.	Block Diagram	14
3.	Memory Channel Configuration	22
4.	Example of Dual Channel Configuration with Dynamic Mode	23
5.	Example of Single Channel Configuration with Dynamic Mode.....	23
6.	Example of Single Channel Configuration without Dynamic Mode.....	24
7.	LAN Connector LED Locations	30
8.	Back Panel Connectors	44
9.	Audio Connectors	46
10.	Power and Hardware Control Connectors	48
11.	D865PCD Add-in Board and Peripheral Interface Connectors.....	51
12.	External I/O Connectors	52
13.	Connection Diagram for Front Panel Connector	53
14.	Connection Diagram for Front Panel USB Connector.....	55
15.	Location of the Jumper Blocks.....	56
16.	Desktop Board D865PCD Dimensions	58
17.	I/O Shield Dimensions	59
18.	Localized High Temperature Zones.....	62

Tables

1.	Feature Summary.....	12
2.	Specifications	16
3.	Supported System Bus Frequency and Memory Speed Combinations.....	20
4.	Supported Memory Configurations	21
5.	Characteristics of Dual/Single Channel Configuration with/without Dynamic Mode.....	22
6.	LAN Connector LED States	30
7.	Effects of Pressing the Power Switch	31
8.	Power States and Targeted System Power	32
9.	Wake-up Devices and Events.....	32
10.	System Memory Map.....	37
11.	DMA Channels	38
12.	I/O Map	38
13.	PCI Configuration Space Map	39
14.	Interrupts	40
15.	PCI Interrupt Routing Map.....	42
16.	ATAPI CD-ROM Connector	47
17.	Front Panel Audio Connector	47
18.	Rear Chassis Fan Connector	49
19.	ATX12V Power Connector.....	49
20.	Processor Fan Connector.....	49
21.	Main Power Connector	49
22.	Front Chassis Fan Connector	50
23.	Chassis Intrusion Connector.....	50
24.	Auxiliary Front Panel Power/Sleep/Message-Waiting LED Connector	53
25.	Front Panel Connector	53

26.	States for a One-Color Power LED.....	54
27.	States for a Two-Color Power LED.....	54
28.	Front Panel Audio Connector/Jumper Block.....	57
29.	BIOS Setup Configuration Jumper Settings.....	57
30.	DC Loading Characteristics.....	60
31.	Fan Connector Current Capability.....	60
32.	Thermal Considerations for Components.....	63
33.	Desktop Board D865PCD Environmental Specifications.....	64
34.	Safety Regulations.....	65
35.	EMC Regulations.....	65
36.	Product Certification Markings.....	67
37.	Boot Device Menu Options.....	74
38.	Supervisor and User Password Functions.....	76
39.	BIOS Setup Program Menu Bar.....	77
40.	BIOS Setup Program Function Keys.....	78
41.	Maintenance Menu.....	78
42.	Main Menu.....	79
43.	Advanced Menu.....	80
44.	PCI Configuration Submenu.....	81
45.	Boot Configuration Submenu.....	82
46.	Peripheral Configuration Submenu.....	83
47.	Drive Configuration Submenu.....	85
48.	PATA Submenus.....	87
49.	Floppy Configuration Submenu.....	88
50.	Event Log Configuration Submenu.....	89
51.	Video Configuration Submenu.....	90
52.	USB Configuration Submenu.....	91
53.	Chipset Configuration Submenu.....	92
54.	Security Menu.....	94
55.	Power Menu.....	95
56.	ACPI Submenu.....	95
57.	Boot Menu.....	96
58.	Boot Device Priority Submenu.....	97
59.	Hard Disk Drives Submenu.....	98
60.	Removable Devices Submenu.....	98
61.	ATAPI CD-ROM Drives Submenu.....	99
62.	Exit Menu.....	99
63.	BIOS Error Messages.....	101
64.	Uncompressed INIT Code Checkpoints.....	103
65.	Boot Block Recovery Code Checkpoints.....	103
66.	Runtime Code Uncompressed in F000 Shadow RAM.....	104
67.	Bus Initialization Checkpoints.....	107
68.	Upper Nibble High Byte Functions.....	107
69.	Lower Nibble High Byte Functions.....	108
70.	Beep Codes.....	109

1 Product Description

What This Chapter Contains

1.1	Overview	12
1.2	Online Support	15
1.3	Design Specifications	16
1.4	Processor	19
1.5	System Memory	20
1.6	Intel® 865P Chipset	24
1.7	I/O Controller	27
1.8	Audio Subsystem.....	28
1.9	LAN Subsystem.....	29
1.10	Chassis Intrusion and Detection	30
1.11	Power Management	30

1.1 Overview

1.1.1 Feature Summary

Table 1 summarizes the major features of the Desktop Board D865PCD.

Table 1. Feature Summary

Form Factor	microATX (9.60 inches by 9.60 inches [243.84 millimeters by 243.84 millimeters])
Processor	<ul style="list-style-type: none"> Support for an Intel® Pentium® 4 processor in an mPGA478 socket with a 400 or 533 MHz system bus Support for an Intel® Celeron® processor in an mPGA478 socket with a 400 MHz system bus
Memory	<ul style="list-style-type: none"> Two 184-pin DDR SDRAM Dual Inline Memory Module (DIMM) sockets Support for DDR 333 and DDR 266 DIMMs Support for up to 2 GB of system memory
Chipset	Intel® 865P Chipset, consisting of: <ul style="list-style-type: none"> Intel® 82865P Memory Controller Hub (MCH) Intel® 82801EB I/O Controller Hub (ICH5) 4 Mbit Firmware Hub (FWH)
Video	Universal 0.8 V / 1.5 V AGP 3.0 connector (with integrated retention mechanism) supporting 1x, 4x, and 8x AGP cards or an AGP Digital Display (ADD) card
Audio	Audio subsystem using the Realtek ALC202 codec
I/O Control	LPC Bus I/O controller
USB	Support for USB 2.0 devices
Peripheral Interfaces	<ul style="list-style-type: none"> Six USB ports One serial port One parallel port Two Parallel ATA IDE interfaces with UDMA 33, ATA-66/100 support One diskette drive interface PS/2* keyboard and mouse ports
LAN Support	10/100 Mb/s LAN subsystem using the Intel® 82562EZ Platform LAN Connect (PLC) device
BIOS	<ul style="list-style-type: none"> Intel/AMI BIOS (resident in the 4 Mbit FWH) Support for Advanced Configuration and Power Interface (ACPI), Plug and Play, and SMBIOS
Instantly Available PC Technology	<ul style="list-style-type: none"> Support for PCI Local Bus Specification Revision 2.2 Suspend to RAM support Wake on PCI, RS-232, front panel, PS/2 devices, and USB ports
Expansion Capabilities	Three PCI bus add-in card connectors (SMBus routed to PCI bus connector 2)

For information about

Refer to

Available configurations for the Desktop Boards D865PCD

Section 1.2, page 16

The board's compliance level with ACPI, Plug and Play, and SMBIOS

Section 1.3, page 16

1.1.2 Board Layout

Figure 1 shows the location of the major components.

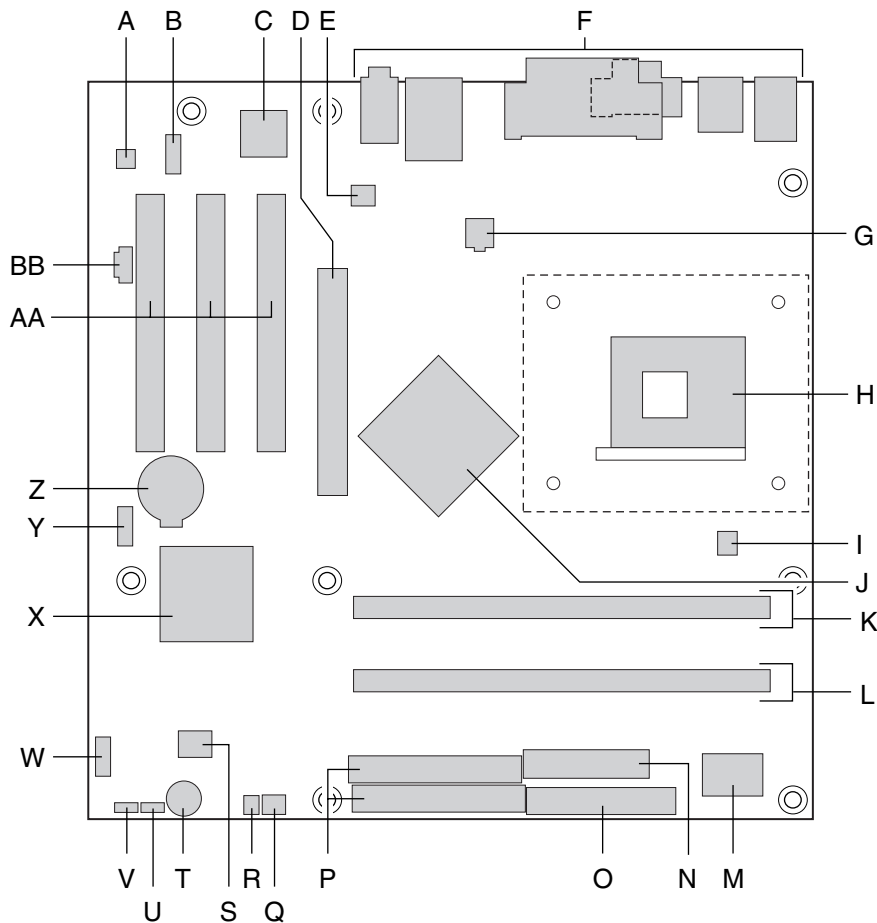

OM17040

A	Audio codec	O	Diskette drive connector
B	Front panel audio connector	P	Parallel ATE IDE connectors
C	Ethernet PLC device (optional)	Q	Front chassis fan connector
D	AGP connector	R	Chassis intrusion connector
E	Rear chassis fan connector	S	4 Mbit Firmware Hub (FWH)
F	Back panel connectors	T	Speaker
G	+12V power connector (ATX12V)	U	BIOS Setup configuration jumper block
H	mPGA478 processor socket	V	Auxiliary front panel power LED connector
I	Processor fan connector	W	Front panel connector
J	Intel 82865P MCH	X	Intel 82801EB I/O Controller Hub (ICH5)
K	DIMM Channel A socket	Y	Front panel USB connector
L	DIMM Channel B socket	Z	Battery
M	I/O controller	AA	PCI bus add-in card connectors
N	Power connector	BB	ATAPI CD-ROM connector

Figure 1. Desktop Board D865PCD Components

1.1.3 Block Diagram

Figure 2 is a block diagram of the major functional areas of the board.

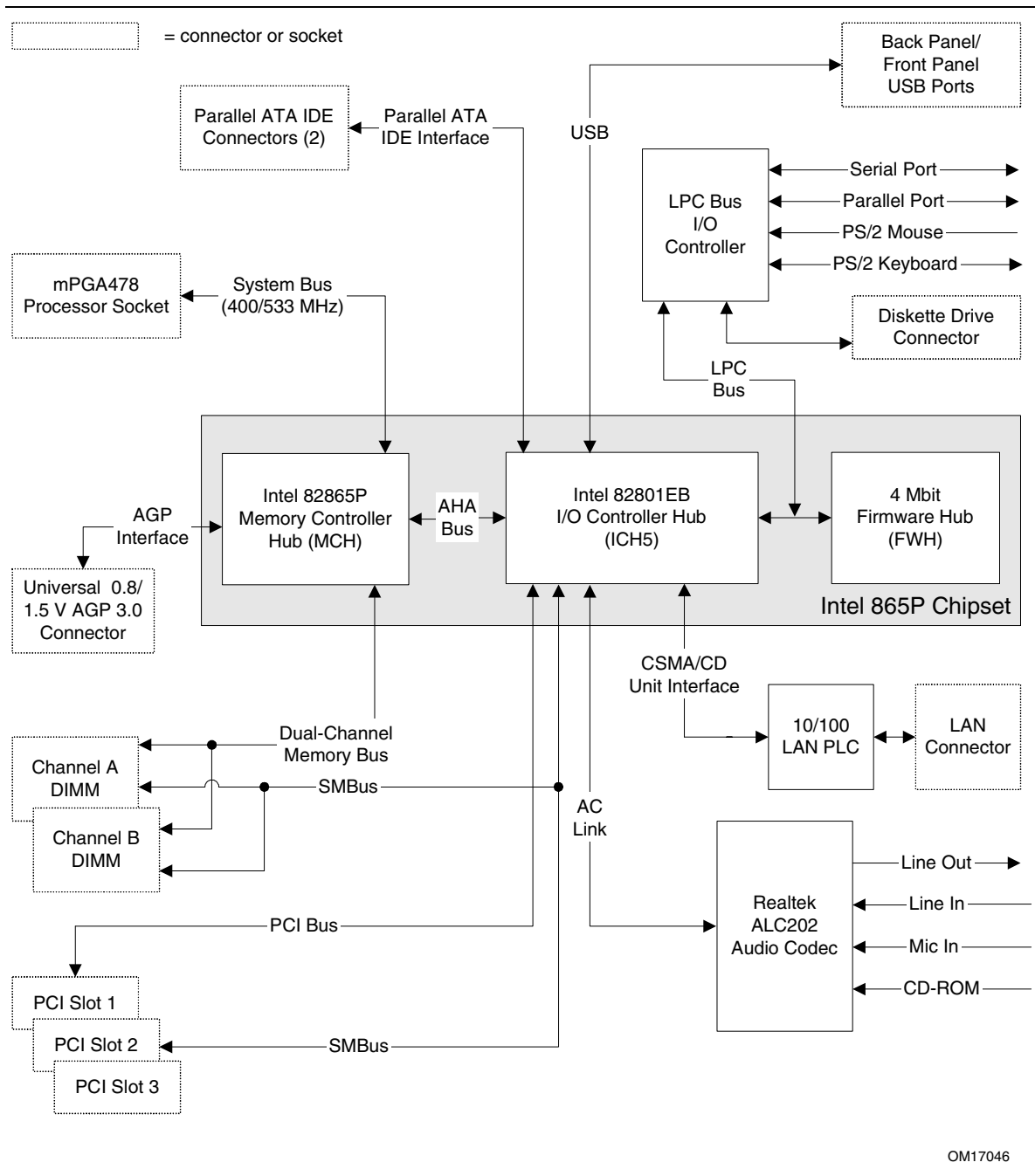

Figure 2. Block Diagram

1.2 Online Support

To find information about...	Visit this World Wide Web site:
Intel Desktop Board D865PCD under "Desktop Board Products" or "Desktop Board Support"	http://www.intel.com/design/motherbd http://support.intel.com/support/motherboards/desktop
Available configurations for the Desktop Board D865PCD	http://developer.intel.com/design/motherbd/cd/cd_available.htm
Processor data sheets	http://www.intel.com/design/litcentr
ICH5 addressing	http://developer.intel.com/design/chipsets/datashts
Custom splash screens	http://intel.com/design/motherbd/gen_indx.htm
Audio software and utilities	http://www.intel.com/design/motherbd
LAN software and drivers	http://www.intel.com/design/motherbd

1.3 Design Specifications

Table 2 lists the specifications applicable to the Desktop Board D865PCD.

Table 2. Specifications

Reference Name	Specification Title	Version, Revision Date, and Ownership	The information is available from...
AC '97	<i>Audio Codec '97</i>	Revision 2.2, September 2000, Intel Corporation.	ftp://download.intel.com/labs/media/audio/download/ac97r22.pdf
ACPI	<i>Advanced Configuration and Power Interface Specification</i>	Version 2.0, July 27, 2000, Compaq Computer Corporation, Intel Corporation, Microsoft Corporation, Phoenix Technologies Limited, and Toshiba Corporation.	http://www.acpi.info/spec.htm
AGP	<i>Accelerated Graphics Port Interface Specification</i>	Revision 3.0, September 2002, Intel Corporation.	http://www.agpforum.org/specs_specs.htm
AMI BIOS	<i>AMIBIOS Desktop Core 8.0</i>	AMIBIOS 8.0, 2001, American Megatrends, Inc.	http://www.ami.com/support/doc/amibios8.pdf
ASF	<i>Alert Standard Format (ASF) Specification</i>	Version 1.03, June 20, 2001, DMTF, Intel Corporation.	http://www.dmtf.org/standards/documents/ASF/DSP0114.pdf
ATA/ATAPI-5	<i>Information Technology-AT Attachment with Packet Interface - 5 (ATA/ATAPI-5)</i>	Revision 3, February 29, 2000, Contact: T13 Chair, Seagate Technology.	http://www.t13.org
ATX	<i>ATX Specification</i>	Version 2.03, December 1998, Intel Corporation.	http://www.formfactors.org/developer/specs/atx/atxspe.htm
ATX12V	<i>ATX/ATX12V Power Supply Design Guide</i>	Version 1.2, August 2000, Intel Corporation.	http://www.formfactors.org/developer/specs/atx/atxspe.htm
BIS	<i>Boot Integrity Services (BIS) Application Programming Interface (API)</i>	Version 1.0, August 4, 1999, Intel Corporation.	http://www.intel.com/labs/manager/wfm/wfmspecs.htm

continued

Table 2. Specifications (continued)

Reference Name	Specification Title	Version, Revision Date and Ownership	The information is available from...
DDR SDRAM	<i>Double Data Rate (DDR) SDRAM Specification</i>	Version 1.0, June 2000, JEDEC Solid State Technology Association.	http://www.jedec.org/
	<i>Design Specification for a 184 Pin DDR Unbuffered DIMM</i>	Revision 1.0, October 2001, JEDEC Solid State Technology Association.	http://www.jedec.org/
	<i>Intel® JEDEC DDR 200/266 Unbuffered DIMM Specification Addendum</i>	Revision 0.9, September 27, 2001, Intel Corporation.	http://developer.intel.com/technology/memory/index.htm
EHCI	<i>Enhanced Host Controller Interface Specification for Universal Serial Bus</i>	Revision 1.0, March 12, 2002, Intel Corporation.	http://developer.intel.com/technology/usb/download/hci-r10.pdf
EPP	<i>IEEE Std 1284.1-1997 (Enhanced Parallel Port)</i>	Version 1.7, 1997, Institute of Electrical and Electronic Engineers.	http://standards.ieee.org/reading/ieee/std_public/description/busarch/1284.1-1997_desc.html
EI Torito	<i>Bootable CD-ROM Format Specification</i>	Version 1.0, January 25, 1995, Phoenix Technologies Limited and International Business Machines Corporation.	http://www.phoenix.com/resources/specs-cdrom.pdf
LPC	<i>Low Pin Count Interface Specification</i>	Revision 1.0, September 29, 1997, Intel Corporation.	http://www.intel.com/design/chipsets/industry/lpc.htm
MicroATX	<i>microATX Motherboard Interface Specification</i>	Version 1.0, December 1997, Intel Corporation.	http://www.formfactors.org/developer/specs/microatx/microatxspecs.htm
PCI	<i>PCI Local Bus Specification</i>	Revision 2.2, December 18, 1998, PCI Special Interest Group.	http://www.pcisig.com/specifications
	<i>PCI Bus Power Management Interface Specification</i>	Revision 1.1, December 18, 1998, PCI Special Interest Group.	http://www.pcisig.com/specifications
Plug and Play	<i>Plug and Play BIOS Specification</i>	Version 1.0a, May 5, 1994, Compaq Computer Corporation, Phoenix Technologies Limited, and Intel Corporation.	http://www.microsoft.com/hwdev/tech/PnP/default.asp

continued

Table 2. Specifications (continued)

Reference Name	Specification Title	Version, Revision Date and Ownership	The information is available from...
PXE	<i>Preboot Execution Environment</i>	Version 2.1, September 20, 1999, Intel Corporation.	ftp://download.intel.com/labs/manage/wfm/download/pxespec.pdf
SFX	<i>SFX/SFX12V Power Supply Design Guide</i>	Version 2.0, May 2001, Intel Corporation.	http://www.formfactors.org/developer/specs/sfx/sfx12v.pdf
SMBIOS	<i>System Management BIOS</i>	Version 2.3.1, March 16, 1999, American Megatrends Incorporated, Award Software International Incorporated, Compaq Computer Corporation, Dell Computer Corporation, Hewlett-Packard Company, Intel Corporation, International Business Machines Corporation, Phoenix Technologies Limited, and SystemSoft Corporation.	http://www.dmtf.org/download/standards/DSP0119.pdf
TFX12V	<i>TFX12V Power Supply Design Guide</i>	Revision 1.01, May 2002, Intel Corporation.	http://www.formfactors.org/developer/specs/tfx12v/tfx12v_psdg_101.pdf
UHCI	<i>Universal Host Controller Interface Design Guide</i>	Revision 1.1, March 1996, Intel Corporation.	http://developer.intel.com/design/USB/UHCI11D.htm
USB	<i>Universal Serial Bus Specification</i>	Revision 2.0, April 27, 2000, Compaq Computer Corporation, Hewlett-Packard Company, Lucent Technologies Inc., Intel Corporation, Microsoft Corporation, NEC Corporation, and Koninklijke Philips Electronics N.V.	http://www.usb.org/developers/docs
WfM	<i>Wired for Management Baseline</i>	Version 2.0, December 18, 1998, Intel Corporation.	http://www.intel.com/labs/manage/wfm/wfmspecs.htm

1.4 Processor

NOTE

Refer to Thermal Considerations (Section 2.12, page 61) for important information when using an Intel Pentium 4 processor operating above 2.80 GHz with this Intel® desktop board.

The board is designed to support the following:

- Intel Pentium 4 processors in an mPGA478 processor socket with a 400 or 533 MHz system bus
- Intel Celeron processors in an mPGA478 processor socket with a 400 MHz system bus

See the Intel web site listed below for the most up-to-date list of supported processors.

For information about...	Refer to:
Supported processors for the D865PCD board	http://www.intel.com/design/motherbd/cd/cd_proc.htm



CAUTION

Use only the processors listed on web site above. Use of unsupported processors can damage the board, the processor, and the power supply.



INTEGRATOR'S NOTES

- *Use only ATX12V-, SFX12V-, or TFX12V-compliant power supplies. ATX12V, SFX12V, and TFX12V power supplies have an additional power lead that provides required supplemental power for the processor. Always connect the 20-pin and 4-pin leads of ATX12V, SFX12V, and TFX12V power supplies to the corresponding connectors on the desktop board, otherwise the board will not boot.*
- *Do not use a standard ATX power supply. The board will not boot with a standard ATX power supply.*
- *Refer to Table 3 on page 20 for a list of supported system bus frequency and memory speed combinations.*

For information about	Refer to
Power supply connectors	Section 2.8.2.2, page 46

1.5 System Memory

The board has two DIMM sockets and supports the following memory features:

- 2.5 V (only) 184-pin DDR SDRAM DIMMs with gold-plated contacts
- Unbuffered, single-sided or double-sided DIMMs with the following restriction:
 - Double-sided DIMMS with x16 organization are not supported.
- 2 GB maximum total system memory
- Minimum total system memory: 64 MB
- Non-ECC DIMMs
- Serial Presence Detect
- DDR333 and DDR266 SDRAM DIMMs

Table 3 lists the supported system bus frequency and memory speed combinations.

Table 3. Supported System Bus Frequency and Memory Speed Combinations

To use this type of DIMM...	The processor's system bus frequency must be...
DDR333	533 MHz
DDR266	533 or 400 MHz

NOTES

- *Remove the AGP video card before installing or upgrading memory to avoid interference with the memory retention mechanism.*
- *To be fully compliant with all applicable DDR SDRAM memory specifications, the board should be populated with DIMMs that support the Serial Presence Detect (SPD) data structure. This allows the BIOS to read the SPD data and program the chipset to accurately configure memory settings for optimum performance. If non-SPD memory is installed, the BIOS will attempt to correctly configure the memory settings, but performance and reliability may be impacted or the DIMMs may not function under the determined frequency.*

For information about

Obtaining DDR SDRAM specifications

Refer to

Section 1.3, page 16

Table 4 lists the supported DIMM configurations.

Table 4. Supported Memory Configurations

DIMM Capacity	Configuration	DDR SDRAM Density	DDR SDRAM Organization Front-side/Back-side	Number of DDR SDRAM Devices
64 MB	SS	64 Mbit	8 M x 8/empty	8
64 MB	SS	128 Mbit	8 M x 16/empty	4
128 MB	DS	64 Mbit	8 M x 8/8 M x 8	16
128 MB	SS	128 Mbit	16 M x 8/empty	8
128 MB	SS	256 Mbit	16 M x 16/empty	4
256 MB	DS	128 Mbit	16 M x 8/16 M x 8	16
256 MB	SS	256 Mbit	32 M x 8/empty	8
256 MB	SS	512 Mbit	32 M x 16/empty	4
512 MB	DS	256 Mbit	32 M x 8/32 M x 8	16
512 MB	SS	512 Mbit	64 M x 8/empty	8
1024 MB	DS	512 Mbit	64 M x 8/64 M x 8	16

Note: In the second column, “DS” refers to double-sided memory modules (containing two rows of DDR SDRAM) and “SS” refers to single-sided memory modules (containing one row of DDR SDRAM).

1.5.1 Memory Configurations

The Intel 82865P MCH component provides two features for enhancing memory throughput:

- Dual Channel memory interface. The board has two memory channels, each with a single DIMM socket, as shown in Figure 3
- Dynamic Addressing Mode. Dynamic mode minimizes overhead by reducing memory accesses

Table 5 summarizes the characteristics of Dual and Single Channel configurations with and without the use of Dynamic Mode.

Table 5. Characteristics of Dual/Single Channel Configuration with/without Dynamic Mode

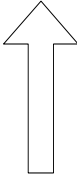
Throughput Level	Configuration	Characteristics
 <p>Highest</p> <p>Lowest</p>	Dual Channel with Dynamic Mode	DIMMs matched (Example configuration shown in Figure 4)
	Single Channel with Dynamic Mode	Single DIMM (Example configuration shown in Figure 5)
	Single Channel without Dynamic Mode	DIMMs not matched (Example configuration shown in Figure 6)

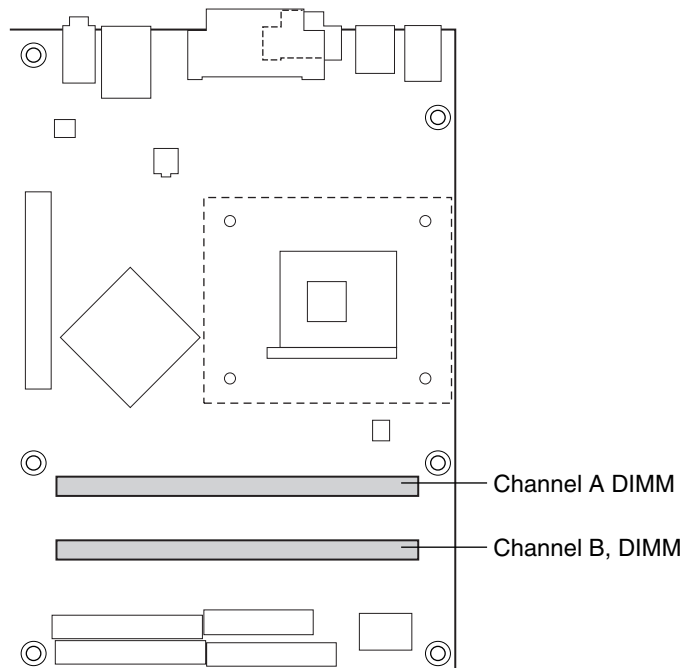

OM17042

Figure 3. Memory Channel Configuration

Single Channel Configuration without Dynamic Mode
(DIMMs not matched)

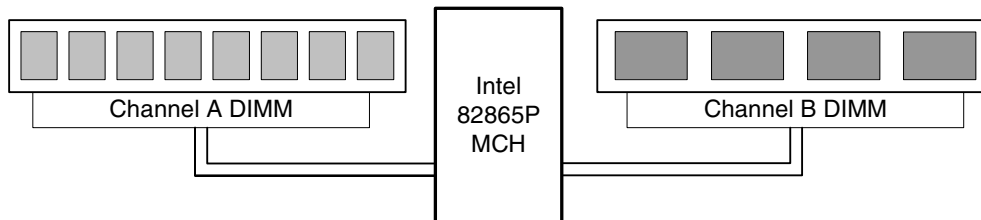

OM17043

Throughput Level	Configuration	Characteristics
Highest  Lowest	Dual Channel with Dynamic Mode	DIMMs matched
	Single Channel with Dynamic Mode	Single DIMM
	Single Channel without Dynamic Mode	DIMMs not matched

Figure 4. Example of Dual Channel Configuration with Dynamic Mode

Single Channel Configuration with Dynamic Mode
(Single DIMM)

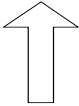
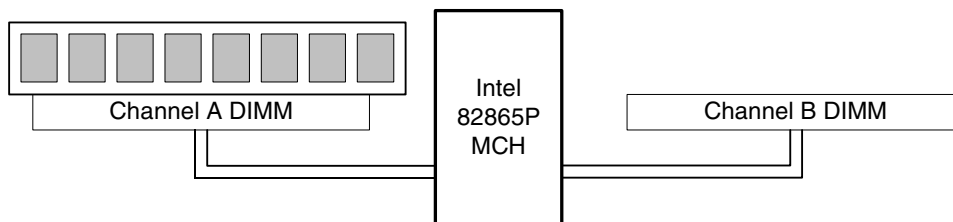

OM17044

Throughput Level	Configuration	Characteristics
Highest  Lowest	Dual Channel with Dynamic Mode	DIMMs matched
	Single Channel with Dynamic Mode	Single DIMM
	Single Channel without Dynamic Mode	DIMMs not matched

Figure 5. Example of Single Channel Configuration with Dynamic Mode

Dual Channel Configuration with Dynamic Mode
(DIMMs matched)

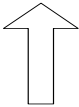
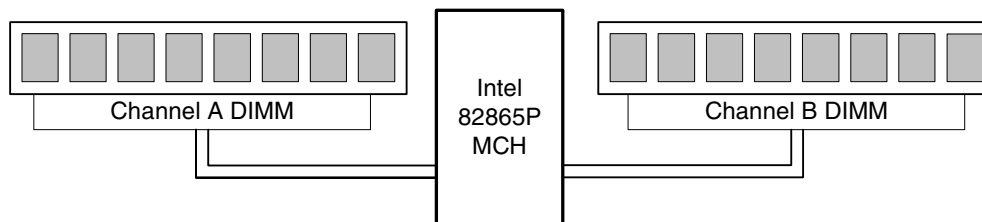

OM17045

Throughput Level	Configuration	Characteristics
Highest  Lowest	Dual Channel with Dynamic Mode	DIMMs matched
	Single Channel with Dynamic Mode	Single DIMM
	Single Channel without Dynamic Mode	DIMMs not matched

Figure 6. Example of Single Channel Configuration without Dynamic Mode

1.6 Intel® 865P Chipset

The Intel 865P chipset consists of the following devices:

- Intel 82865P Memory Controller Hub (MCH) with Accelerated Hub Architecture (AHA) bus
- Intel 82801EB I/O Controller Hub (ICH5) with AHA bus
- Firmware Hub (FWH)

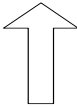
The MCH is a centralized controller for the system bus, the memory bus, the AGP bus, and the Accelerated Hub Architecture interface. The ICH5 is a centralized controller for the board's I/O paths. The FWH provides the nonvolatile storage of the BIOS.

For information about

Refer to

The Intel 865P chipset

<http://developer.intel.com/>

Resources used by the chipset

Chapter 2

1.6.1 Universal 0.8 V / 1.5 V AGP 3.0 Connector

The AGP connector supports the following:

- 4x, 8x AGP 3.0 add-in cards with 0.8 V I/O
- 1x, 4x AGP 2.0 add-in cards with 1.5 V I/O
- AGP Digital Display (ADD) cards

AGP is a high-performance interface for graphics-intensive applications, such as 3D applications. While based on the *PCI Local Bus Specification*, Rev. 2.2, AGP is independent of the PCI bus and is intended for exclusive use with graphical display devices. AGP overcomes certain limitations of the PCI bus related to handling large amounts of graphics data with the following features:

- Pipelined memory read and write operations that hide memory access latency
- Demultiplexing of address and data on the bus for nearly 100 percent efficiency

INTEGRATOR'S NOTES

- *AGP 2x operation is not supported.*
- *Install memory in the DIMM sockets prior to installing the AGP video card to avoid interference with the memory retention mechanism.*
- *The AGP connector is keyed for Universal 0.8 V AGP 3.0 cards or 1.5 V AGP 2.0 cards only. Do not attempt to install a legacy 3.3 V AGP card. The AGP connector is not mechanically compatible with legacy 3.3 V AGP cards.*

For information about	Refer to
The location of the AGP connector	Figure 1, page 13
Obtaining the <i>Accelerated Graphics Port Interface Specification</i>	Section 1.3, page 16

1.6.2 USB

The board supports up to six USB 2.0 ports, supports UHCI and EHCI, and uses UHCI- and EHCI-compatible drivers.

The ICH5 provides the USB controller for all ports. The port arrangement is as follows:

- Two ports are implemented with stacked back panel connectors, adjacent to the PS/2 connectors
- Two ports are implemented with stacked back panel connectors, adjacent to the audio connectors
- Two ports are routed to a front panel USB connector

NOTES

- *Computer systems that have an unshielded cable attached to a USB port may not meet FCC Class B requirements, even if no device is attached to the cable. Use shielded cable that meets the requirements for full-speed devices.*
- *Native USB 2.0 support has been tested with drivers for Windows* 2000 (with Service Pack 3) and Windows XP (with Service Pack 1) and is not currently supported by any other operating system. Check Intel's Desktop Board website for possible driver updates for other operating systems.*

For information about	Refer to
The location of the USB connectors on the back panel	Figure 8, page 44
The location of the front panel USB connector	Figure 12, page 52
The EHCI, front panel, UHCI, and USB specifications	Section 1.3, page 16

1.6.3 IDE Support

The board provides two Parallel ATA IDE connectors, which support a total of four devices (two per connector). The ICH5's Parallel ATA IDE controller has two independent bus-mastering Parallel ATA IDE interfaces that can be independently enabled. The Parallel ATA IDE interfaces support the following modes:

- Programmed I/O (PIO): processor controls data transfer.
- 8237-style DMA: DMA offloads the processor, supporting transfer rates of up to 16 MB/sec.
- Ultra DMA: DMA protocol on IDE bus supporting host and target throttling and transfer rates of up to 33 MB/sec.
- ATA-66: DMA protocol on IDE bus supporting host and target throttling and transfer rates of up to 66 MB/sec. ATA-66 protocol is similar to Ultra DMA and is device driver compatible.
- ATA-100: DMA protocol on IDE bus allows host and target throttling. The ICH5's ATA-100 logic can achieve read transfer rates up to 100 MB/sec and write transfer rates up to 88 MB/sec.

NOTE

ATA-66 and ATA-100 are faster timings and require a specialized cable to reduce reflections, noise, and inductive coupling.

The Parallel ATA IDE interfaces also support ATAPI devices (such as CD-ROM drives) and ATA devices using the transfer modes listed in Section 4.4.4.1 on page 86.

The BIOS supports Logical Block Addressing (LBA) and Extended Cylinder Head Sector (ECHS) translation modes. The drive reports the transfer rate and translation mode to the BIOS.

The board supports Laser Servo (LS-120) diskette technology through the Parallel ATA IDE interfaces. An LS-120 drive can be configured as a boot device by setting the BIOS Setup program's Boot menu to one of the following:

- ARMD-FDD (ATAPI removable media device – floppy disk drive)
- ARMD-HDD (ATAPI removable media device – hard disk drive)

For information about

The location of the Parallel ATA IDE connectors

Refer to

Figure 11, page 51

1.6.4 Real-Time Clock, CMOS SRAM, and Battery

A coin-cell battery (CR2032) powers the real-time clock and CMOS memory. When the computer is not plugged into a wall socket, the battery has an estimated life of three years. When the computer is plugged in, the standby current from the power supply extends the life of the battery. The clock is accurate to ± 13 minutes/year at 25 °C with 3.3 VSB applied.

NOTE

If the battery and AC power fail, custom defaults, if previously saved, will be loaded into CMOS RAM at power-on.

1.7 I/O Controller

The I/O controller provides the following features:

- One serial port
- One parallel port with Extended Capabilities Port (ECP) and Enhanced Parallel Port (EPP) support
- Serial IRQ interface compatible with serialized IRQ support for PCI systems
- PS/2-style mouse and keyboard interfaces
- Interface for one 1.44 MB or 2.88 MB diskette drive
- Intelligent power management, including a programmable wake-up event interface
- PCI power management support

The BIOS Setup program provides configuration options for the I/O controller.

For information about	Refer to
SMSC LPC47M172 I/O controller	http://www.smsc.com
National Semiconductor PC87372 I/O Controller	http://www.national.com/

1.7.1 Serial Port

The boards have one serial port connector located on the back panel. The serial port supports data transfers at speeds up to 115.2 kbits/sec with BIOS support.

For information about	Refer to
The location of the serial port A connector	Figure 8, page 44

1.7.2 Parallel Port

The 25-pin D-Sub parallel port connector is located on the back panel. Use the BIOS Setup program to set the parallel port mode.

For information about	Refer to
The location of the parallel port connector	Figure 8, page 44
Setting the parallel port's mode	Table 46, page 83

1.7.3 Diskette Drive Controller

The I/O controller supports one diskette drive. Use the BIOS Setup program to configure the diskette drive interface.

For information about	Refer to
The location of the diskette drive connector on the D865PCD board	Figure 11, page 51
The supported diskette drive capacities and sizes	Table 49, page 88

1.7.4 Keyboard and Mouse Interface

PS/2 keyboard and mouse connectors are located on the back panel.

NOTE

The keyboard is supported in the bottom PS/2 connector and the mouse is supported in the top PS/2 connector. Power to the computer should be turned off before a keyboard or mouse is connected or disconnected.

For information about	Refer to
The location of the keyboard and mouse connectors	Figure 8, page 44

1.8 Audio Subsystem

The board provides an audio subsystem based on the Realtek ALC202 codec.

1.8.1 Realtek ALC202-based Audio Subsystem

The Realtek ALC202-based audio subsystem consists of the following devices:

- Intel 82801EB I/O Controller Hub (ICH5)
- Realtek ALC202 audio codec

The audio subsystem includes these features:

- Signal-to-noise ratio ≥ 90 dB
- Supports wake events (driver dependent)
- Mic in pre-amp that supports dynamic, condenser, and electret microphones

The back panel audio connectors for this audio subsystem including the following:

- Line out
- Line in
- Mic in

1.8.2 Audio Connectors

1.8.2.1 Front Panel Audio Connector

A 2 x 5-pin connector provides mic in and line out signals for front panel audio connectors.

For information about	Refer to
The location of the connector	Figure 9, page 46
The signal names of the front panel audio connector	Table 17, page 47

NOTE

The front panel audio connector is alternately used as a jumper block for routing audio signals. Refer to Section 2.9.1 on page 56 for more information.

1.8.2.2 ATAPI CD-ROM Audio Connector

A 1 x 4-pin ATAPI-style connector connects an internal ATAPI CD-ROM drive to the audio mixer.

For information about	Refer to
The location of the ATAPI CD-ROM connector	Figure 9, page 46
The signal names of the ATAPI CD-ROM connector	Table 16, page 47

1.8.3 Audio Subsystem Software

Audio software and drivers are available from Intel's World Wide Web site.

For information about	Refer to
Obtaining audio software and drivers	Section 1.2, page 15

1.9 LAN Subsystem

The 10/100 Mbits/sec LAN subsystem consists of the following:

- Intel® 82562EZ Platform LAN Connect (PLC) device for 10/100 Mbits/sec Ethernet LAN connectivity
- Intel 82801EB ICH5 (with its CSMA/CD interface)
- RJ-45 LAN connector with integrated status LEDs

Additional features of the LAN subsystem include:

- PCI bus master interface
- CSMA/CD protocol engine
- PCI power management
 - Supports ACPI technology
 - Supports LAN wake capabilities

1.9.1 Intel® 82562EZ Physical Layer Interface Device

The Intel 82562EZ provides the following functions:

- Basic 10/100 Ethernet LAN connectivity
- Full device driver compatibility
- Programmable transit threshold
- Configuration EEPROM that contains the MAC address

1.9.2 RJ-45 LAN Connector with Integrated LEDs

Two LEDs are built into the RJ-45 LAN connector (shown in Figure 7 below).

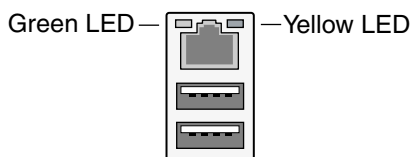

OM15076

Figure 7. LAN Connector LED Locations

Table 6 describes the LED states when the board is powered up and the 10/100 Mbps/sec LAN subsystem is operating.

Table 6. LAN Connector LED States

LED Color	LED State	Condition
Green	Off	LAN link is not established
	On	LAN link is established
	Blinking	LAN activity is occurring
Yellow	Off	10 Mbps/sec data rate is selected
	On	100 Mbps/sec data rate is selected

1.9.3 LAN Subsystem Software

LAN software and drivers are available from Intel's World Wide Web site.

For information about

Obtaining LAN software and drivers

Refer to

Section 1.2, page 15

1.10 Chassis Intrusion and Detection

The Desktop Board D865PCD supports a chassis security feature that detects if the chassis cover is removed. The security feature uses a mechanical switch on the chassis that attaches to the chassis intrusion connector. When the chassis cover is removed, the mechanical switch is in the closed position.

1.11 Power Management

Power management is implemented at several levels, including:

- Software support through Advanced Configuration and Power Interface (ACPI)
- Hardware support:
 - Power connector
 - Fan connectors
 - LAN wake capabilities
 - Instantly Available PC technology
 - Resume on Ring
 - Wake from USB
 - Wake from PS/2 devices

— Power Management Event signal (PME#) wake-up support

1.11.1 ACPI

ACPI gives the operating system direct control over the power management and Plug and Play functions of a computer. The use of ACPI with the Desktop Board D865PCD requires an operating system that provides full ACPI support. ACPI features include:

- Plug and Play (including bus and device enumeration)
- Power management control of individual devices, add-in boards (some add-in boards may require an ACPI-aware driver), video displays, and hard disk drives
- Methods for achieving less than 15-watt system operation in the power-on/standby sleeping state
- A Soft-off feature that enables the operating system to power-off the computer
- Support for multiple wake-up events (see Table 9 on page 32)
- Support for a front panel power and sleep mode switch

Table 7 lists the system states based on how long the power switch is pressed, depending on how ACPI is configured with an ACPI-aware operating system.

Table 7. Effects of Pressing the Power Switch

If the system is in this state...	...and the power switch is pressed for	...the system enters this state
Off (ACPI G2/G5 – Soft off)	Less than four seconds	Power-on (ACPI G0 – working state)
On (ACPI G0 – working state)	Less than four seconds	Soft-off/Standby (ACPI G1 – sleeping state)
On (ACPI G0 – working state)	More than four seconds	Fail safe power-off (ACPI G2/G5 – Soft off)
Sleep (ACPI G1 – sleeping state)	Less than four seconds	Wake-up (ACPI G0 – working state)
Sleep (ACPI G1 – sleeping state)	More than four seconds	Power-off (ACPI G2/G5 – Soft off)
For information about		Refer to
The Desktop Boards' compliance level with ACPI		Section 1.3, page 16

1.11.1.1 System States and Power States

Under ACPI, the operating system directs all system and device power state transitions. The operating system puts devices in and out of low-power states based on user preferences and knowledge of how devices are being used by applications. Devices that are not being used can be turned off. The operating system uses information from applications and user settings to put the system as a whole into a low-power state.

Table 8 lists the power states supported by the Desktop Board D865PCD and along with the associated system power targets. See the ACPI specification for a complete description of the various system and power states.

Table 8. Power States and Targeted System Power

Global States	Sleeping States	Processor States	Device States	Targeted System Power (Note 1)
G0 – working state	S0 – working	C0 – working	D0 – working state.	Full power > 30 W
G1 – sleeping state	S1 – Processor stopped	C1 – stop grant	D1, D2, D3 – device specification specific.	5 W < power < 52.5 W
G1 – sleeping state	S3 – Suspend to RAM. Context saved to RAM.	No power	D3 – no power except for wake-up logic.	Power < 5 W (Note 2)
G1 – sleeping state	S4 – Suspend to disk. Context saved to disk.	No power	D3 – no power except for wake-up logic.	Power < 5 W (Note 2)
G2/S5	S5 – Soft off. Context not saved. Cold boot is required.	No power	D3 – no power except for wake-up logic.	Power < 5 W (Note 2)
G3 – mechanical off AC power is disconnected from the computer.	No power to the system.	No power	D3 – no power for wake-up logic, except when provided by battery or external source.	No power to the system. Service can be performed safely.

Notes:

1. Total system power is dependent on the system configuration, including add-in boards and peripherals powered by the system chassis' power supply.
2. Dependent on the standby power consumption of wake-up devices used in the system.

1.11.1.2 Wake-up Devices and Events

Table 9 lists the devices or specific events that can wake the computer from specific states.

Table 9. Wake-up Devices and Events

These devices/events can wake up the computer...	...from this state
LAN	S1, S3, S4, S5 (Note)
Modem (back panel Serial Port A)	S1, S3
PME# signal	S1, S3, S4, S5 (Note)
Power switch	S1, S3, S4, S5
PS/2 devices	S1, S3
RTC alarm	S1, S3, S4, S5
USB	S1, S3

Note: For LAN and PME# signal, S5 is disabled by default in the BIOS Setup program. Setting this option to Power On will enable a wake-up event from LAN in the S5 state.

 **NOTE**

The use of these wake-up events from an ACPI state requires an operating system that provides full ACPI support. In addition, software, drivers, and peripherals must fully support ACPI wake events.

1.11.2 Hardware Support

 **CAUTION**

Ensure that the power supply provides adequate +5 V standby current if LAN wake capabilities and Instantly Available PC technology features are used. Failure to do so can damage the power supply. The total amount of standby current required depends on the wake devices supported and manufacturing options.

The Desktop Board D865PCD provides several power management hardware features, including:

- Power connector
- Fan connectors
- LAN wake capabilities
- Instantly Available PC technology
- Resume on Ring
- Wake from USB
- Wake from PS/2 keyboard
- PME# signal wake-up support

LAN wake capabilities and Instantly Available PC technology require power from the +5 V standby line. The sections discussing these features describe the incremental standby power requirements for each.

Resume on Ring enables telephony devices to access the computer when it is in a power-managed state. The method used depends on the type of telephony device (external or internal).

 **NOTE**

The use of Resume on Ring and Wake from USB technologies from an ACPI state requires an operating system that provides full ACPI support.

1.11.2.1 Power Connector

ATX12V-, SFX12V-, and TFX12V-compliant power supplies can turn off the system power through system control. When an ACPI-enabled system receives the correct command, the power supply removes all non-standby voltages.

When resuming from an AC power failure, the computer returns to the power state it was in before power was interrupted (on or off). The computer's response can be set using the Last Power State feature in the BIOS Setup program's Boot menu.

For information about	Refer to
The location of the power connector	Figure 9, page 46
The signal names of the power connector	Table 21, page 49
The BIOS Setup program's Boot menu	Table 57, page 96
The ATX12V, SFX12V, and TFX12V specifications	Section 1.3, page 16

1.11.2.2 LAN Wake Capabilities



CAUTION

For LAN wake capabilities, the +5 V standby line for the power supply must be capable of providing adequate +5 V standby current. Failure to provide adequate standby current when implementing LAN wake capabilities can damage the power supply.

LAN wake capabilities enable remote wake-up of the computer through a network. The LAN subsystem PCI bus network adapter monitors network traffic at the Media Independent Interface. Upon detecting a Magic Packet* frame, the LAN subsystem asserts a wake-up signal that powers up the computer. Depending on the LAN implementation, the Desktop Board D865PCD support LAN wake capabilities with ACPI in the following ways:

- The PCI bus PME# signal for PCI 2.2 compliant LAN designs
- The onboard LAN subsystem

1.11.2.3 Instantly Available PC Technology



CAUTION

For Instantly Available PC technology, the +5 V standby line for the power supply must be capable of providing adequate +5 V standby current. Failure to provide adequate standby current when implementing Instantly Available PC technology can damage the power supply.

Instantly Available PC technology enables the Desktop Board D865PCD to enter the ACPI S3 (Suspend-to-RAM) sleep-state. While in the S3 sleep-state, the computer will appear to be off (the power supply is off, and the front panel LED is amber if dual colored, or off if single colored.) When signaled by a wake-up device or event, the system quickly returns to its last known wake state. Table 9 on page 32 lists the devices and events that can wake the computer from the S3 state.

The Desktop Board D865PCD supports the *PCI Bus Power Management Interface Specification*. For information on the version of this specification, see Section 1.3. Add-in boards that also support this specification can participate in power management and can be used to wake the computer.

The use of Instantly Available PC technology requires operating system support and PCI 2.2 compliant add-in cards and drivers.

1.11.2.4 Resume on Ring

The operation of Resume on Ring can be summarized as follows:

- Resumes operation from ACPI S1 or S3 states
- Detects incoming call similarly for external and internal modems
- Requires modem interrupt be unmasked for correct operation

1.11.2.5 Wake from USB

USB bus activity wakes the computer from ACPI S1 or S3 states.

 **NOTE**

Wake from USB requires the use of a USB peripheral that supports Wake from USB.

1.11.2.6 Wake from PS/2 Devices

PS/2 device activity wakes the computer from an ACPI S1 or S3 state.

1.11.2.7 PME# Signal Wake-up Support

When the PME# signal on the PCI bus is asserted, the computer wakes from an ACPI S1, S3, S4, or S5 state (with Wake on PME enabled in BIOS).

2 Technical Reference

What This Chapter Contains

2.1	Introduction.....	37
2.2	Memory Map	37
2.3	DMA Channels	38
2.4	Fixed I/O Map.....	38
2.5	PCI Configuration Space Map	39
2.6	Interrupts	40
2.7	PCI Interrupt Routing Map.....	41
2.8	Connectors.....	43
2.9	Jumper Blocks.....	56
2.10	Mechanical Considerations.....	58
2.11	Electrical Considerations	60
2.12	Thermal Considerations.....	61
2.13	Reliability	63
2.14	Environmental	64

2.1 Introduction

Sections 2.2 - 2.6 contain several standalone tables. Table 10 describes the system memory map, Table 11 lists the DMA channels, Table 12 shows the I/O map, Table 13 defines the PCI configuration space map, and Table 14 describes the interrupts. The remaining sections in this chapter are introduced by text found with their respective section headings.

2.2 Memory Map

Table 10 lists the system memory map.

Table 10. System Memory Map

Address Range (decimal)	Address Range (hex)	Size	Description
1024 K - 2097152 K	100000 - 7FFFFFFF	2047 MB	Extended memory
960 K - 1024 K	F0000 - FFFFF	64 KB	Runtime BIOS
896 K - 960 K	E0000 - EFFFF	64 KB	Reserved
800 K - 896 K	C8000 - DFFFF	96 KB	Potential available high DOS memory (open to the PCI bus). Dependent on video adapter used.
640 K - 800 K	A0000 - C7FFF	160 KB	Video memory and BIOS
639 K - 640 K	9FC00 - 9FFFF	1 KB	Extended BIOS data (movable by memory manager software)
512 K - 639 K	80000 - 9FBFF	127 KB	Extended conventional memory
0 K - 512 K	00000 - 7FFFF	512 KB	Conventional memory

2.3 DMA Channels

Table 11. DMA Channels

DMA Channel Number	Data Width	System Resource
0	8 or 16 bits	Open
1	8 or 16 bits	Parallel port
2	8 or 16 bits	Diskette drive
3	8 or 16 bits	Parallel port (for ECP or EPP)
4	8 or 16 bits	DMA controller
5	16 bits	Open
6	16 bits	Open
7	16 bits	Open

2.4 Fixed I/O Map

Table 12. I/O Map

Address (hex)	Size	Description
0000 - 00FF	256 bytes	Used by the Desktop Board D865PCD. Refer to the ICH5 data sheet for dynamic addressing information.
0170 - 0177	8 bytes	Secondary Parallel ATA IDE channel command block
01F0 - 01F7	8 bytes	Primary Parallel ATA IDE channel command block
0228 - 022F (Note 1)	8 bytes	LPT3
0278 - 027F (Note 1)	8 bytes	LPT2
02E8 - 02EF (Note 1)	8 bytes	COM4
02F8 - 02FF (Note 1)	8 bytes	COM2
0374 - 0377	4 bytes	Secondary Parallel ATA IDE channel control block
0377, bits 6:0	7 bits	Secondary IDE channel status port
0378 - 037F	8 bytes	LPT1
03B0 - 03BB	12 bytes	Intel 82865P MCH
03C0 - 03DF	32 bytes	Intel 82865P MCH
03E8 - 03EF	8 bytes	COM3
03F0 - 03F5	6 bytes	Diskette channel
03F4 - 03F7	1 byte	Primary Parallel ATA IDE channel control block
03F8 - 03FF	8 bytes	COM1
04D0 - 04D1	2 bytes	Edge/level triggered PIC
LPTn + 400	8 bytes	ECP port, LPTn base address + 400h
0CF8 - 0CFB (Note 2)	4 bytes	PCI configuration address register
0CF9 (Note 3)	1 byte	Reset control register
0CFC - 0CFF	4 bytes	PCI configuration data register
FFA0 - FFA7	8 bytes	Primary Parallel ATA IDE bus master registers
FFA8 - FFAF	8 bytes	Secondary Parallel ATA IDE bus master registers

Notes:

1. Default, but can be changed to another address range
2. Dword access only
3. Byte access only

 **NOTE**

Some additional I/O addresses are not available due to ICH5 address aliasing. The ICH5 data sheet provides more information on address aliasing.

For information about

Obtaining the ICH5 data sheet

Refer to

Section 1.2 on page 15

2.5 PCI Configuration Space Map

Table 13. PCI Configuration Space Map

Bus Number (hex)	Device Number (hex)	Function Number (hex)	Description
00	00	00	Memory controller of Intel 82865P component
00	01	00	Host to AGP bridge (virtual PCI-to-PCI)
00	03	00	PCI to CSA Bridge (virtual PCI-to-PCI)
00	1E	00	Hub link to PCI bridge
00	1F	00	Intel 82801EB ICH5 PCI to LPC bridge
00	1F	01	Parallel ATA IDE controller
00	1F	03	SMBus controller
00	1F	05	AC '97 audio controller
00	1F	06	AC '97 modem controller
00	1D	00	USB UHCI controller 1
00	1D	01	USB UHCI controller 2
00	1D	02	USB UHCI controller 3
00	1D	03	USB UHCI controller 4
00	1D	07	EHCI controller
01	00	00	AGP add-in card
(Note)	01	00	Intel 82547EI Gigabit LAN PLC (if present)
(Note)	08	00	Intel 82562EZ 10/100 Mb/s LAN PLC (if present)
(Note)	00	00	PCI bus connector 1
(Note)	01	00	PCI bus connector 2
(Note)	02	00	PCI bus connector 3

Note: Bus number = 03 when the Intel 82547EI Gigabit LAN controller is used. Otherwise, bus number = 02.

2.6 Interrupts

The interrupts can be routed through either the Programmable Interrupt Controller (PIC) or the Advanced Programmable Interrupt Controller (APIC) portion of the ICH5 component. The PIC is supported in Windows 98 SE and Windows ME and uses the first 16 interrupts. The APIC is supported in Windows 2000 and Windows XP and supports a total of 24 interrupts.

Table 14. Interrupts

IRQ	System Resource
NMI	I/O channel check
0	Reserved, interval timer
1	Reserved, keyboard buffer full
2	Reserved, cascade interrupt from slave PIC
3	COM2 (Note 1)
4	COM1 (Note 1)
5	LPT2 (Plug and Play option)/User available
6	Diskette drive
7	LPT1 (Note 1)
8	Real-time clock
9	Reserved for ICH5 system management bus
10	User available
11	User available
12	Onboard mouse port (if present, else user available)
13	Reserved, math coprocessor
14	Primary IDE
15	Secondary IDE
16 (Note 2)	USB UHCI controller 1 / USB UHCI controller 4 (through PIRQA)
17 (Note 2)	AC '97 audio/modem/User available (through PIRQB)
18 (Note 2)	ICH5 USB controller 3 (through PIRQC)
19 (Note 2)	ICH5 USB controller 2 (through PIRQD)
20 (Note 2)	ICH5 LAN (through PIRQE)
21 (Note 2)	User available (through PIRQF)
22 (Note 2)	User available (through PIRQG)
23 (Note 2)	ICH5 USB 2.0 EHCI controller/User available (through PIRQH)

Notes:

1. Default, but can be changed to another IRQ.
2. Available in APIC mode only.

2.7 PCI Interrupt Routing Map

This section describes interrupt sharing and how the interrupt signals are connected between the PCI bus connectors and onboard PCI devices. The PCI specification specifies how interrupts can be shared between devices attached to the PCI bus. In most cases, the small amount of latency added by interrupt sharing does not affect the operation or throughput of the devices. In some special cases where maximum performance is needed from a device, a PCI device should not share an interrupt with other PCI devices. Use the following information to avoid sharing an interrupt with a PCI add-in card.

PCI devices are categorized as follows to specify their interrupt grouping:

- **INTA:** By default, all add-in cards that require only one interrupt are in this category. For almost all cards that require more than one interrupt, the first interrupt on the card is also classified as INTA.
- **INTB:** Generally, the second interrupt on add-in cards that require two or more interrupts is classified as INTB. (This is not an absolute requirement.)
- **INTC and INTD:** Generally, a third interrupt on add-in cards is classified as INTC and a fourth interrupt is classified as INTD.

The ICH5 has eight Programmable Interrupt Request (PIRQ) input signals. All PCI interrupt sources either onboard or from a PCI add-in card connect to one of these PIRQ signals. Some PCI interrupt sources are electrically tied together on the Desktop Boards D865PCD and therefore share the same interrupt. Table 15 shows an example of how the PIRQ signals are routed.

For example, using Table 15 as a reference, assume an add-in card using INTA is plugged into PCI bus connector 3. In PCI bus connector 3, INTA is connected to PIRQB, which is already connected to the ICH5 audio controller. The add-in card in PCI bus connector 3 now shares an interrupt with the onboard interrupt source.

Table 15. PCI Interrupt Routing Map

PCI Interrupt Source	ICH5 PIRQ Signal Name							
	PIRQA	PIRQB	PIRQC	PIRQD	PIRQE	PIRQF	PIRQG	PIRQH
AGP connector	INTA	INTB						
ICH5 USB UHCI controller 1	INTA							
SMBus controller		INTB						
ICH5 USB UHCI controller 2				INTB				
AC '97 ICH5 Audio		INTB						
ICH5 LAN					INTA			
ICH5 USB UHCI controller 3			INTC					
ICH5 USB UHCI controller 4	INTA							
ICH5 USB 2.0 EHCI controller								INTD
PCI bus connector 1					INTD	INTA	INTB	INTC
PCI bus connector 2					INTC	INTB	INTA	INTD
PCI bus connector 3	INTD	INTA	INTB	INTC				

 **NOTE**

In PIC mode, the ICH5 can connect each PIRQ line internally to one of the IRQ signals (3, 4, 5, 6, 7, 9, 10, 11, 12, 14, and 15). Typically, a device that does not share a PIRQ line will have a unique interrupt. However, in certain interrupt-constrained situations, it is possible for two or more of the PIRQ lines to be connected to the same IRQ signal. Refer to Table 14 for the allocation of PIRQ lines to IRQ signals in APIC mode.

2.8 Connectors



CAUTION

Only the following connectors have overcurrent protection: back panel USB, front panel USB, and PS/2.

The other internal connectors are not overcurrent protected and should connect only to devices inside the computer's chassis, such as fans and internal peripherals. Do not use these connectors to power devices external to the computer's chassis. A fault in the load presented by the external devices could cause damage to the computer, the power cable, and the external devices themselves.

This section describes the board's connectors. The connectors can be divided into these groups:

- Back panel I/O connectors (see page 44)
 - PS/2 keyboard and mouse
 - USB (four ports)
 - Parallel port
 - Serial port A
 - LAN
 - Audio (line out, line in, and mic in)
- Internal I/O connectors (see page 45)
 - Audio (ATAPI CD-ROM and front panel audio)
 - Fans [three]
 - Power
 - Add-in boards (PCI and AGP)
 - Parallel ATA IDE
 - Diskette drive
 - Chassis intrusion
- External I/O connectors (see page 52)
 - Front panel USB (two connector for four ports)
 - Auxiliary front panel power/sleep/message-waiting LED
 - Front panel (power/sleep/message-waiting LED, power switch, hard drive activity LED, reset switch, and auxiliary front panel power LED)



NOTE

When installing the board in a microATX chassis, make sure that peripheral devices are installed at least 1.5 inches above the main power connector, the diskette drive connector, the Parallel ATA IDE connectors, and the DIMM sockets.

2.8.1 Back Panel Connectors

Figure 8 shows the location of the back panel connectors. The back panel connectors are color-coded in compliance with PC 99 recommendations. The figure legend below lists the colors used.

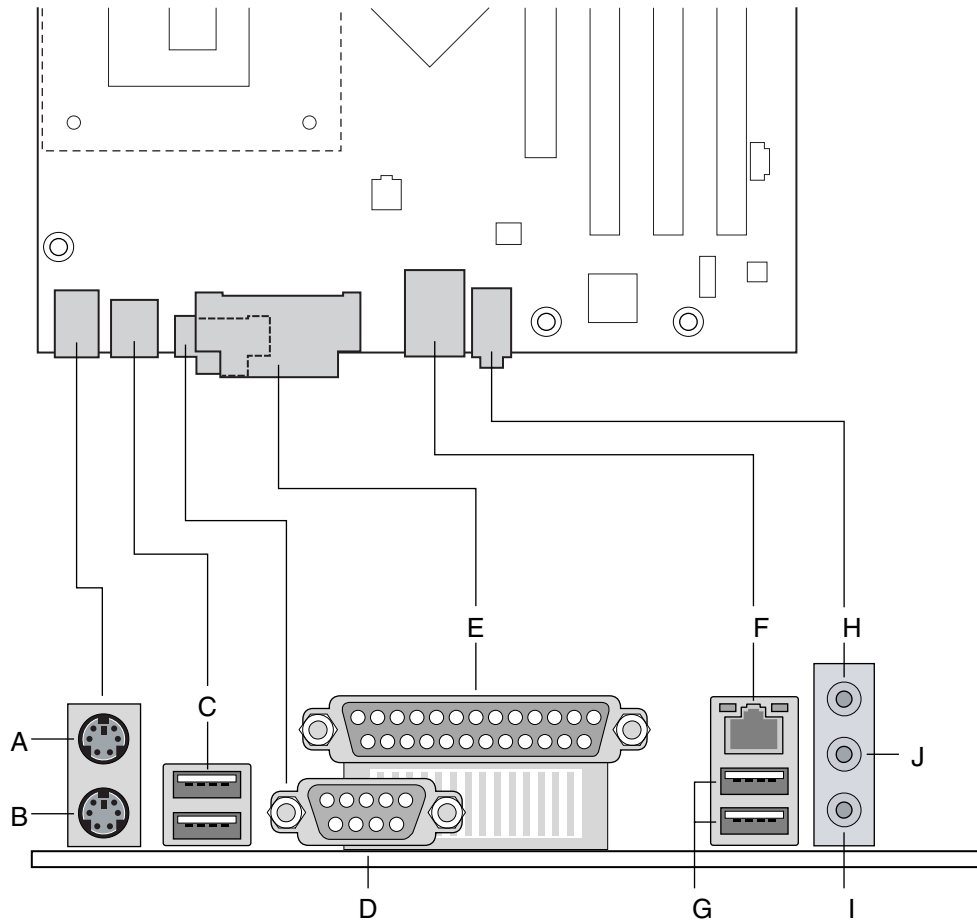

OM17034

Item	Description	Color	Item	Description	Color
A	PS/2 mouse port	Green	F	LAN	Black
B	PS/2 keyboard port	Purple	G	USB ports	Black
C	USB ports	Black	H	Audio line in	Light blue
D	Serial port A	Teal	I	Mic in	Pink
E	Parallel port	Burgundy	J	Audio line out	Lime green

Figure 8. Back Panel Connectors

 **NOTE**

The back panel audio line out connector is designed to power headphones or amplified speakers only. Poor audio quality occurs if passive (non-amplified) speakers are connected to this output.

2.8.2 Internal I/O Connectors

The internal I/O connectors are divided into the following functional groups:

- Audio (see page 46)
 - ATAPI CD-ROM
 - Front panel audio
- Power and hardware control (see page 48)
 - Fans [3]
 - ATX12V power
 - Main power
 - Chassis intrusion
- Add-in boards and peripheral interfaces (see page 51)
 - PCI bus
 - AGP
 - IDE
 - Diskette drive

2.8.2.1 Expansion Slots

The board has the following expansion slots:

- AGP connector: The AGP connector is keyed for Universal 0.8 V AGP 3.0 cards or 1.5 V AGP 2.0 cards only. Do not install a legacy 3.3 V AGP card. The AGP connector is not mechanically compatible with legacy 3.3 V AGP cards.
- Three PCI rev 2.2 compliant local bus slots. The SMBus is routed to PCI bus connector 2 only (ATX expansion slot 6). PCI add-in cards with SMBus support can access sensor data and other information residing on the Desktop Board.

NOTE

This document references back-panel slot numbering with respect to processor location on the board. The AGP slot is not numbered. PCI slots are identified as PCI slot #x, starting with the slot closest to the processor. Figure 11 (page 51) illustrates the board's PCI slot numbering.

2.8.2.2 Audio Connectors

Figure 9 shows the location of the audio connectors.

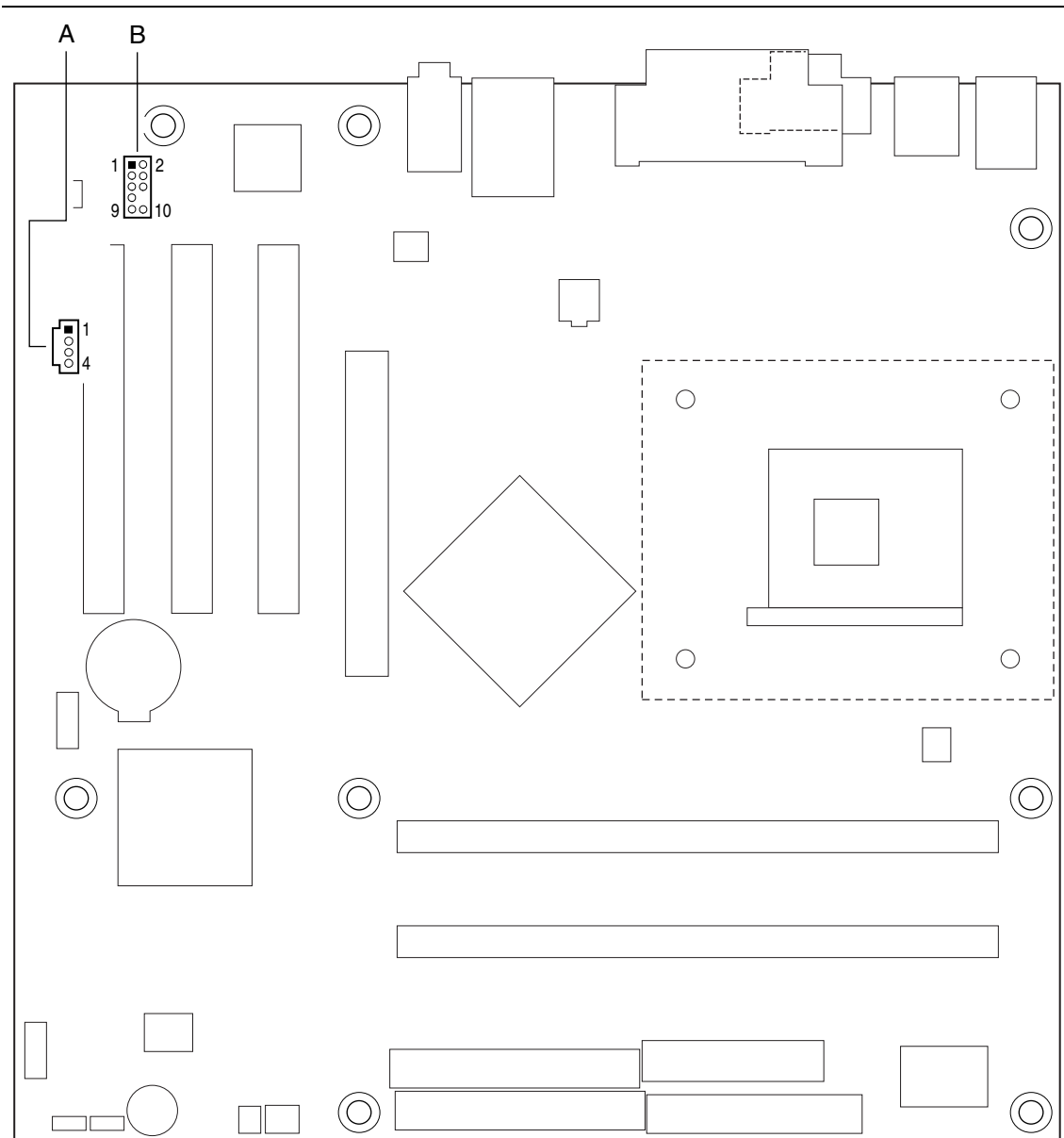

OM17035

Item	Description	For more information see:
A	ATAPI CD-ROM (black)	Table 16
B	Front panel audio	Table 17

Figure 9. Audio Connectors

Table 16. ATAPI CD-ROM Connector

Pin	Signal Name
1	Left audio input from CD-ROM
2	CD audio differential ground
3	CD audio differential ground
4	Right audio input from CD-ROM

Table 17. Front Panel Audio Connector

Pin	Signal Name	Pin	Signal Name
1	Mono Mic in (Stereo Mic 1)	2	Ground
3	Mono Mic Bias (Stereo Mic 2)	4	+5 V
5	RIGHT_OUT	6	Right channel return
7	Ground	8	Key
9	LEFT_OUT	10	Left channel return

 **INTEGRATOR'S NOTE**

The front panel audio connector is alternately used as a jumper block for routing audio signals. Refer to Section 2.9.1 on page 56 for more information.

2.8.2.3 Power and Hardware Control Connectors

Figure 10 shows the location of the power and hardware control connectors.

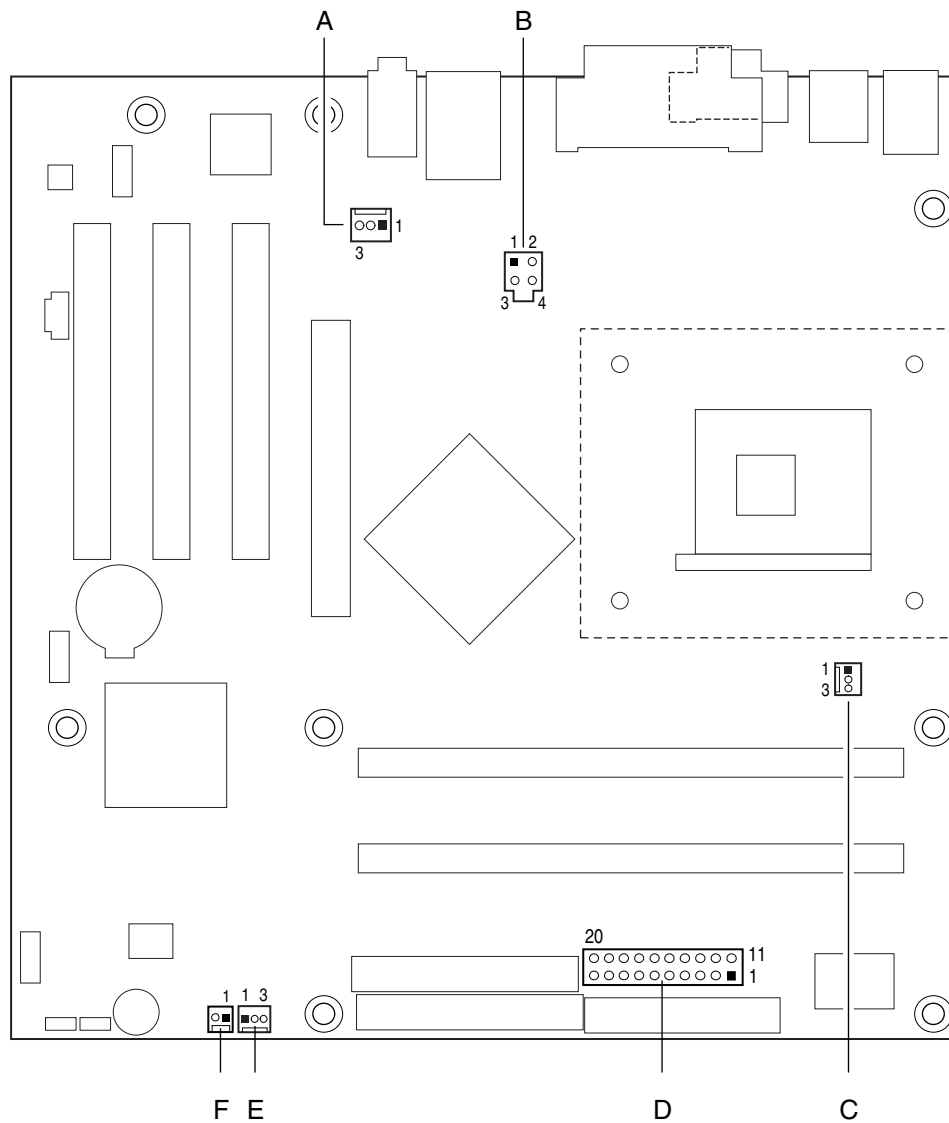

OM17036

Item	Description	For more information see:
A	Rear chassis fan	Table 18
B	+12 V power connector (ATX12V)	Table 19
C	Processor fan	Table 20
D	Main power	Table 21
E	Front chassis fan	Table 22
F	Chassis intrusion	Table 23

Figure 10. Power and Hardware Control Connectors

Table 18. Rear Chassis Fan Connector

Pin	Signal Name
1	Control
2	+12 V
3	REAR_TACH_OUT



INTEGRATOR'S NOTES

- Use only ATX12V-, SFX12V-, or TFX12V-compliant power supplies with the Desktop Board D865PCD. ATX12V, SFX12V, and TFX12V power supplies have an additional power lead that provides required supplemental power for the processor. Always connect the 20-pin and 4-pin leads of ATX12V, SFX12V, and TFX12V power supplies to the corresponding connectors on the desktop board, otherwise the board will not boot.
- Do not use a standard ATX power supply. The board will not boot with a standard ATX power supply.

Table 19. ATX12V Power Connector

Pin	Signal Name	Pin	Signal Name
1	Ground	2	Ground
3	+12 V	4	+12 V

Table 20. Processor Fan Connector

Pin	Signal Name
1	Control
2	+12 V
3	CPU_FAN_TACH

Table 21. Main Power Connector

Pin	Signal Name	Pin	Signal Name
1	+3.3 V	11	+3.3 V
2	+3.3 V	12	-12 V
3	Ground	13	Ground
4	+5 V	14	PS-ON# (power supply remote on/off)
5	Ground	15	Ground
6	+5 V	16	Ground
7	Ground	17	Ground
8	PWRGD (Power Good)	18	No connect
9	+5 V (Standby)	19	+5 V
10	+12 V	20	+5 V

Table 22. Front Chassis Fan Connector

Pin	Signal Name
1	Control
2	+12 V
3	Tach

Table 23. Chassis Intrusion Connector

Pin	Signal Name
1	Intruder
2	Ground

2.8.2.4 Add-in Board and Peripheral Interface Connectors

Figure 11 shows the location of the add-in board connector and peripheral connectors. Note the following considerations for the PCI bus connectors:

- All of the PCI bus connectors are bus master capable.
- SMBus signals are routed to PCI bus connector 2. This enables PCI bus add-in boards with SMBus support to access sensor data on the Desktop Board. The specific SMBus signals are as follows:
 - The SMBus clock line is connected to pin A40.
 - The SMBus data line is connected to pin A41.

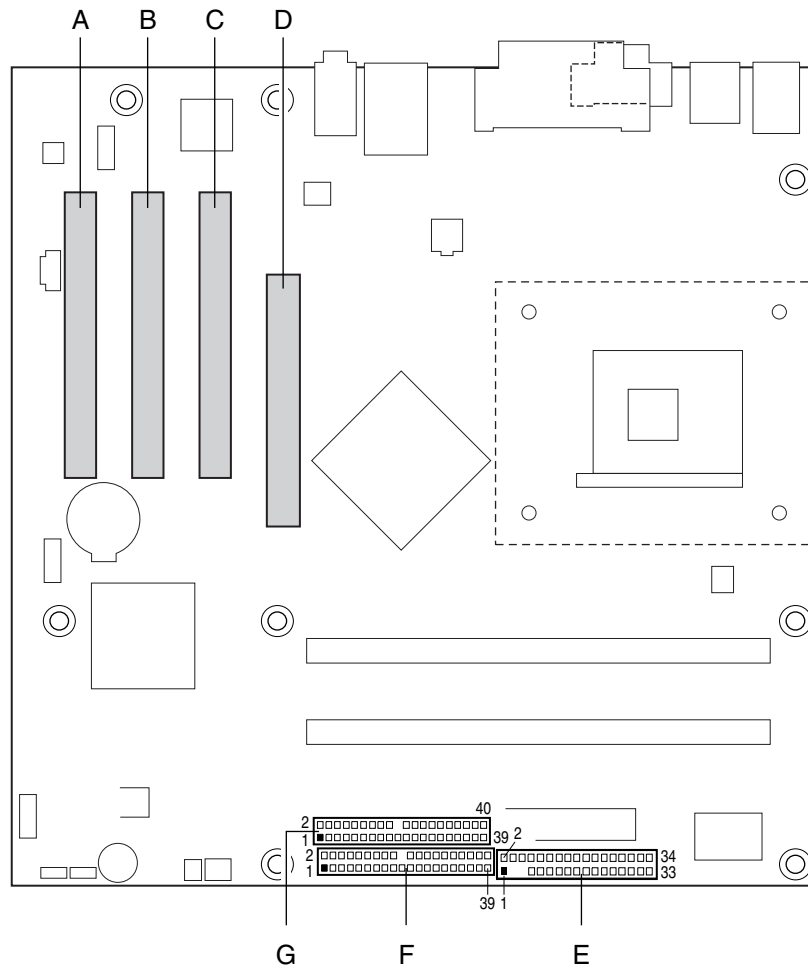

OM17037

Item	Description	Item	Description
A	PCI bus connector 3	E	Diskette drive
B	PCI bus connector 2	F	Primary IDE [black]
C	PCI bus connector 1	G	Secondary IDE [white]
D	AGP connector		

Figure 11. D865PCD Add-in Board and Peripheral Interface Connectors

INTEGRATOR'S NOTES

- The AGP connector is keyed for Universal 0.8 V AGP 3.0 cards or 1.5 V AGP 2.0 cards only. Do not attempt to install a legacy 3.3 V AGP card. The AGP connector is not mechanically compatible with legacy 3.3 V AGP cards.
- Not all PCI video cards can be used in PCI bus connectors 1 and 2 (the PCI bus connectors closest to the processor). To avoid clearance problems, install PCI video cards in PCI bus connector 3.

2.8.3 External I/O Connectors

Figure 12 shows the locations of the external I/O connectors.

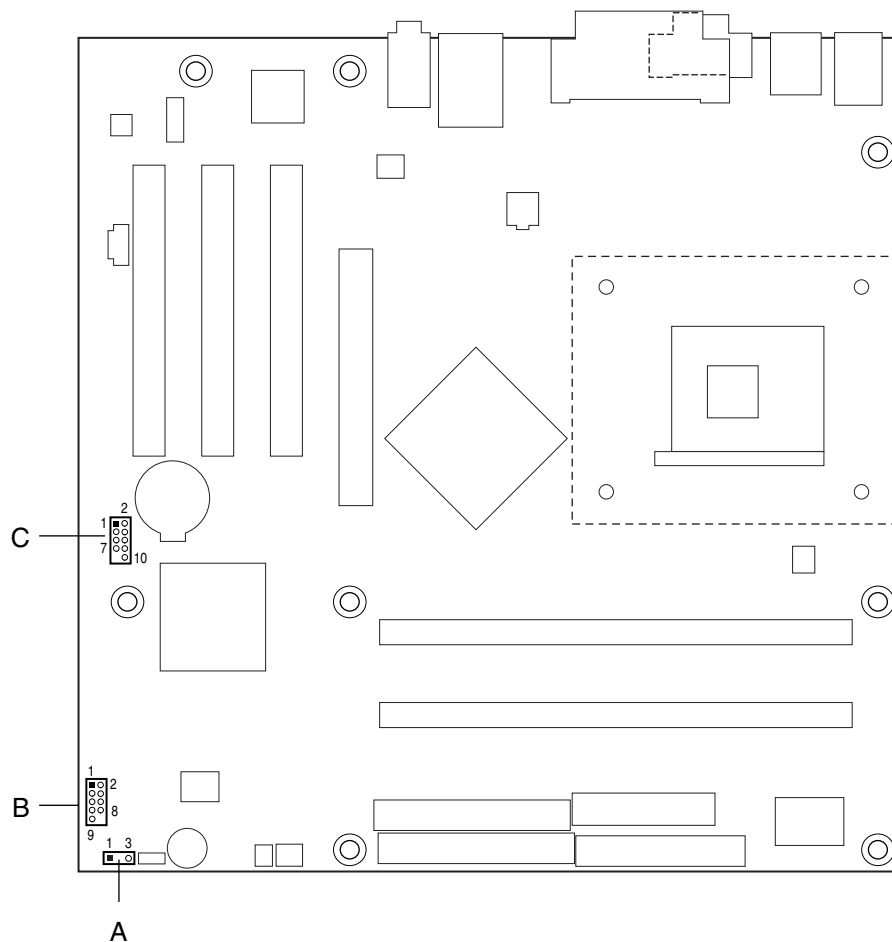

OM17038

Item	Description	Color	For more information see:
A	Auxiliary front panel power/sleep/message-waiting LED	Black	Table 24
B	Front panel	White	Table 25
C	Front panel USB	Black	Figure 14

Figure 12. External I/O Connectors

2.8.3.1 Auxiliary Front Panel Power/Sleep/Message-Waiting LED Connector

Pins 1 and 3 of this connector duplicate the signals on pins 2 and 4 of the front panel connector.

Table 24. Auxiliary Front Panel Power/Sleep/Message-Waiting LED Connector

Pin	Signal Name	In/Out	Description
1	HDR_BLNK_GRN	Out	Front panel green LED
2	Not connected		
3	HDR_BLNK_YEL	Out	Front panel yellow LED

2.8.3.2 Front Panel Connector

This section describes the functions of the front panel connector. Table 25 lists the signal names of the front panel connector. Figure 13 is a connection diagram for the front panel connector.

Table 25. Front Panel Connector

Pin	Signal	In/Out	Description	Pin	Signal	In/Out	Description
Hard Drive Activity LED				Power LED			
1	HD_PWR	Out	Hard disk LED pull-up (750 Ω) to +5 V	2	HDR_BLNK_GRN	Out	Front panel green LED
3	HAD#	Out	Hard disk active LED	4	HDR_BLNK_YEL	Out	Front panel yellow LED
Reset Switch				On/Off Switch			
5	Ground		Ground	6	FPBUT_IN	In	Power switch
7	FP_RESET#	In	Reset switch	8	Ground		Ground
Power				Not Connected			
9	+5 V		Power	10	N/C		Not connected

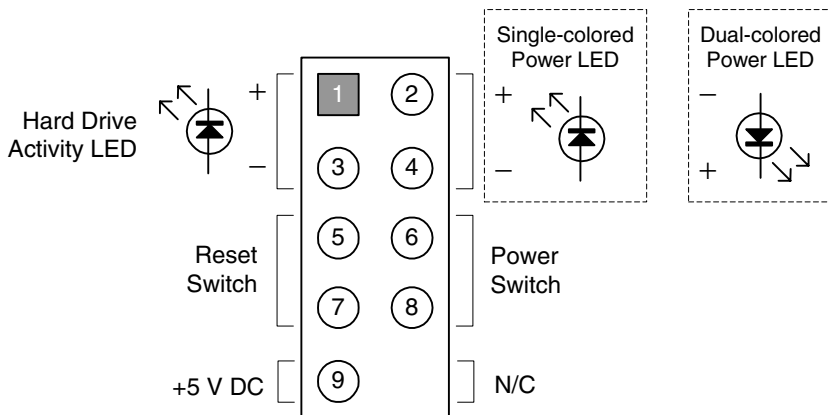

OM16110

Figure 13. Connection Diagram for Front Panel Connector

2.8.3.2.1 Hard Drive Activity LED Connector

Pins 1 and 3 can be connected to an LED to provide a visual indicator that data is being read from or written to a hard drive. Proper LED function requires an IDE hard drive connected to an onboard IDE connector.

2.8.3.2.2 Reset Switch Connector

Pins 5 and 7 can be connected to a momentary single pole, single throw (SPST) type switch that is normally open. When the switch is closed, the board resets and runs the POST.

2.8.3.2.3 Power/Sleep/Message Waiting LED Connector

Pins 2 and 4 can be connected to a one- or two-color LED. Table 26 shows the possible states for a one-color LED. Table 27 shows the possible states for a two-color LED.

Table 26. States for a One-Color Power LED

LED State	Description
Off	Power off/sleeping
Steady Green	Running
Blinking Green	Running/message waiting

Table 27. States for a Two-Color Power LED

LED State	Description
Off	Power off
Steady Green	Running
Blinking Green	Running/message waiting
Steady Yellow	Sleeping
Blinking Yellow	Sleeping/message waiting

NOTE

To use the message waiting function, ACPI must be enabled in the operating system and a message-capturing application must be invoked.

2.8.3.2.4 Power Switch Connector

Pins 6 and 8 can be connected to a front panel momentary-contact power switch. The switch must pull the SW_ON# pin to ground for at least 50 ms to signal the power supply to switch on or off. (The time requirement is due to internal debounce circuitry on the board.) At least two seconds must pass before the power supply will recognize another on/off signal.

2.8.3.3 Front Panel USB Connectors

Figure 14 is a connection diagram for the front panel USB connector.

INTEGRATOR'S NOTES

- *The +5 V DC power on the USB connector is fused.*
- *Pins 1, 3, 5, and 7 comprise one USB port.*
- *Pins 2, 4, 6, and 8 comprise one USB port.*
- *Use only a front panel USB connector that conforms to the USB 2.0 specification for high-speed USB devices.*

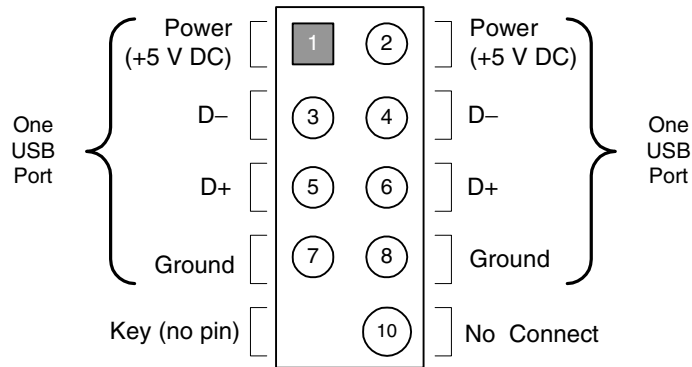

OM15963

Figure 14. Connection Diagram for Front Panel USB Connector

2.9 Jumper Blocks



CAUTION

Do not move any jumpers with the power on. Always turn off the power and unplug the power cord from the computer before changing a jumper setting. Otherwise, the board could be damaged.

Figure 15 shows the location of the jumper blocks.

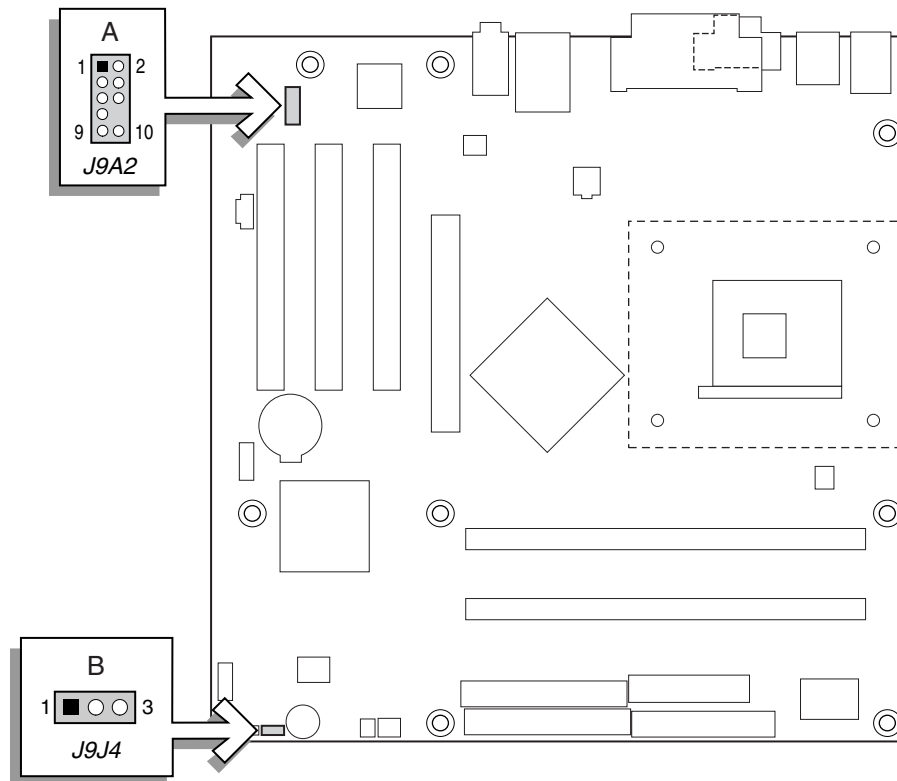

OM17039

Item	Description	Reference Designator
A	Front panel audio connector/jumper block	J9A2
B	BIOS Setup configuration jumper block	J9J4

Figure 15. Location of the Jumper Blocks

2.9.1 Front Panel Audio Connector/Jumper Block

This connector has two functions:

- With jumpers installed, the audio line out signals are routed to the back panel audio line out connector.
- With jumpers removed, the connector provides audio line out and mic in signals for front panel audio connectors.

Table 28 describes the two configurations of this connector/jumper block.



CAUTION

Do not place jumpers on this block in any configuration other than the one described in Table 28. Other jumper configurations are not supported and could damage the Desktop Board.

Table 28. Front Panel Audio Connector/Jumper Block

Jumper Setting	Configuration
	<p>Audio line out signals are routed to the back panel audio line out connector. The back panel audio line out connector is shown in Figure 8 on page 44.</p>
	<p>Audio line out and mic in signals are available for front panel audio connectors. Table 17 on page 47 lists the names of the signals available on this connector when no jumpers are installed.</p>



INTEGRATOR'S NOTE

When the jumpers are removed and this connector is used for front panel audio, the back panel audio line out and mic in connectors are disabled.

2.9.2 BIOS Setup Configuration Jumper Block

The 3-pin jumper block determines the BIOS Setup program's mode. Table 29 describes the jumper settings for the three modes: normal, configure, and recovery. When the jumper is set to configure mode and the computer is powered-up, the BIOS compares the processor version and the microcode version in the BIOS and reports if the two match.

Table 29. BIOS Setup Configuration Jumper Settings

Function/Mode	Jumper Setting	Configuration
Normal	1-2	The BIOS uses current configuration information and passwords for booting.
Configure	2-3	After the POST runs, Setup runs automatically. The maintenance menu is displayed.
Recovery	None	The BIOS attempts to recover the BIOS configuration. A recovery diskette is required.

2.10 Mechanical Considerations

2.10.1 Form Factor

The Desktop Board D865PCD is designed to fit into either a microATX or an ATX-form-factor chassis. Figure 16 illustrates the mechanical form factor for the Desktop Board D865PCD. Dimensions are given in inches [millimeters]. The outer dimensions are 9.60 inches by 9.60 inches [243.84 millimeters by 243.84 millimeters]. Location of the I/O connectors and mounting holes are in compliance with the ATX specification (see Section 1.3).

 **NOTE**

When installing the Desktop Board in a microATX chassis, make sure that peripheral devices are installed at least 1.5 inches above the main power connector, the diskette drive connector, and the IDE connector, and the DIMM sockets.

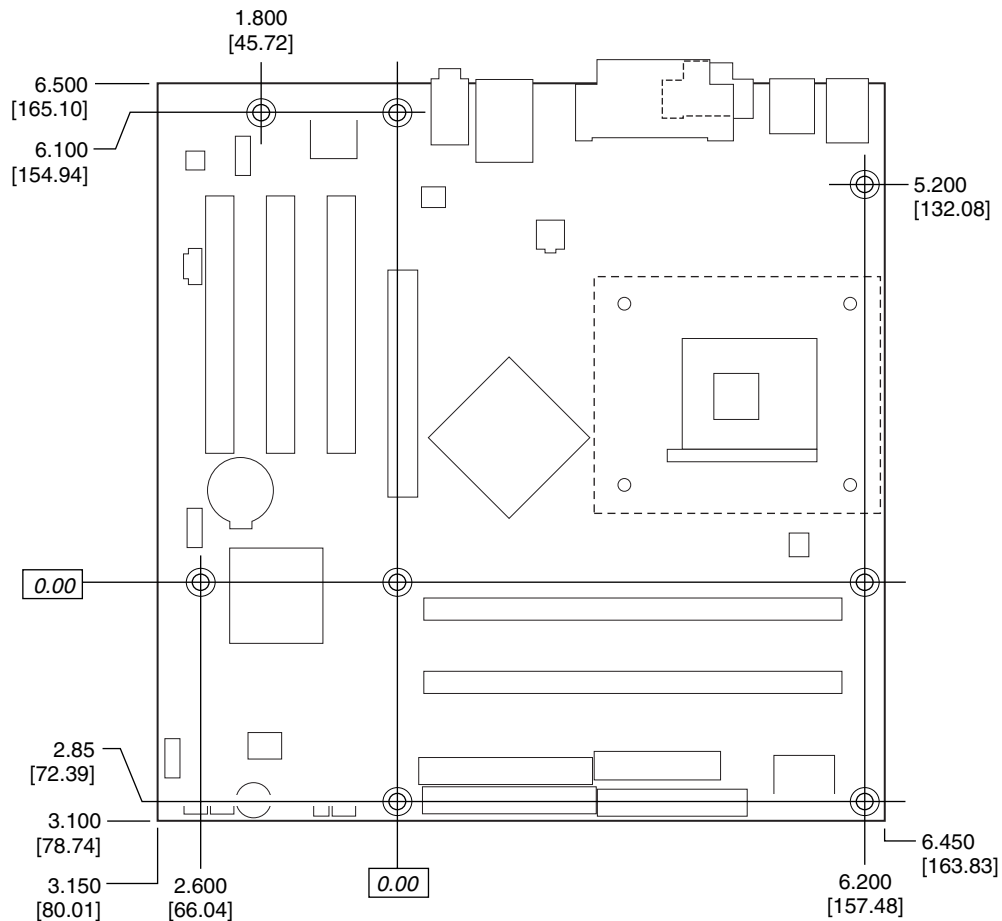

OM17042

Figure 16. Desktop Board D865PCD Dimensions

2.10.2 I/O Shield

The back panel I/O shield for the Desktop Board D865PCD must meet specific dimension and material requirements. Systems based on this Desktop Board need the back panel I/O shield to pass certification testing. Figure 17 shows the I/O shield. Dimensions are given in inches to a tolerance of ± 0.02 inches.

The figure also indicates the position of each cutout. Additional design considerations for I/O shields relative to chassis requirements are described in the ATX specification. See Section 1.3 for information about the ATX specification.

 **NOTE**

The I/O shield drawings in this document are for reference only. An I/O shield compliant with the ATX chassis specification 2.03 is available from Intel.

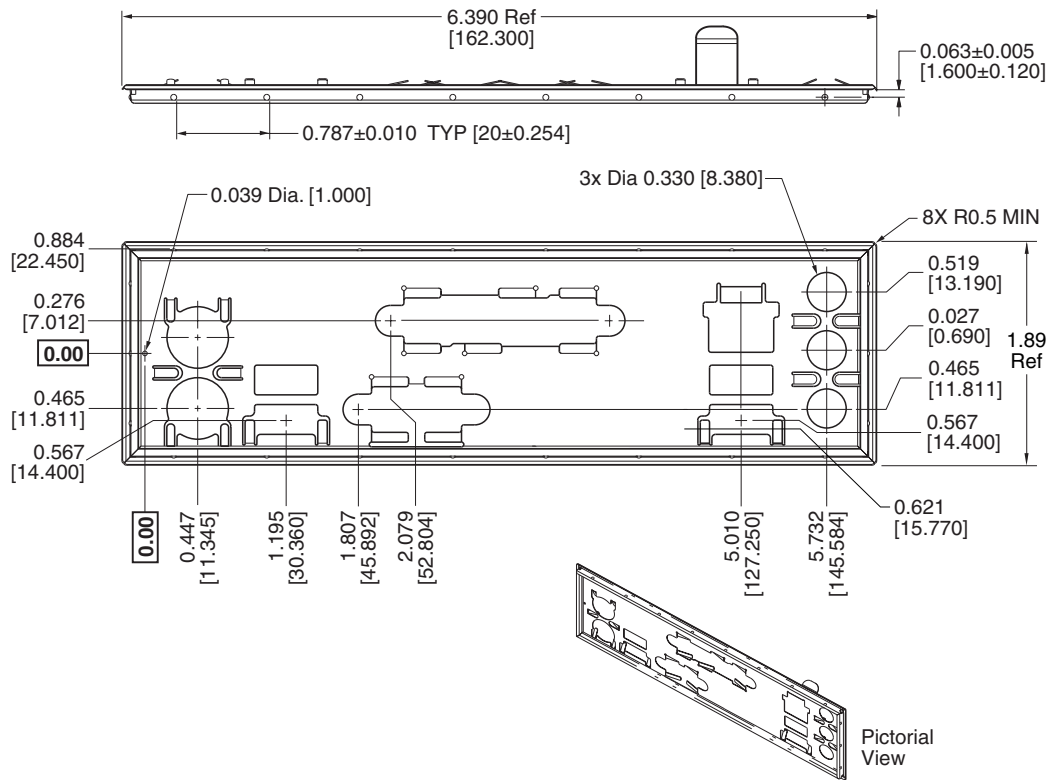

OM12352

Figure 17. I/O Shield Dimensions

2.11 Electrical Considerations

2.11.1 DC Loading

Table 30 lists the DC loading characteristics of the board. This data is based on a DC analysis of all active components within the board that impact its power delivery subsystems. The analysis does not include PCI add-in cards. Minimum values assume a light load placed on the board that is similar to an environment with no applications running and no USB current draw. Maximum values assume a load placed on the board that is similar to a heavy gaming environment with a 500 mA current draw per USB port. These calculations are not based on specific processor values or memory configurations but are based on the minimum and maximum current draw possible from the board's power delivery subsystems to the processor, memory, and USB ports.

Use the datasheets for add-in cards, such as PCI, to determine the overall system power requirements. The selection of a power supply at the system level is dependent on the system's usage model and not necessarily tied to a particular processor speed.

Table 30. DC Loading Characteristics

Mode	DC Power	DC Current at:				
		+3.3 V	+5 V	+12 V	-12 V	+5 VSB
Minimum loading	190.00 W	5.00 A	11.00 A	9.00 A	0.03 A	0.60 A
Maximum loading	286.00 W	11.00 A	15.00 A	13.00 A	0.10 A	1.38 A

2.11.2 Add-in Board Considerations

The boards are designed to provide 2 A (average) of +5 V current for each add-in board. The total +5 V current draw for add-in boards for a fully loaded Desktop Board D865PCD (all three expansion slots and the AGP slot filled) must not exceed 8 A.

2.11.3 Fan Connector Current Capability



CAUTION

The processor fan must be connected to the processor fan connector, not to a chassis fan connector. Connecting the processor fan to a chassis fan connector may result in onboard component damage that will halt fan operation.

Table 31 lists the current capability of the fan connectors.

Table 31. Fan Connector Current Capability

Fan Connector	Maximum Available Current
Processor fan	1600 mA
Front chassis fan	600 mA
Rear chassis fan	600 mA

2.11.4 Power Supply Considerations



CAUTION

The +5 V standby line for the power supply must be capable of providing adequate +5 V standby current. Failure to do so can damage the power supply. The total amount of standby current required depends on the wake devices supported and manufacturing options.

System integrators should refer to the power usage values listed in Table 30 when selecting a power supply for use with the board.

Additional power required will depend on configurations chosen by the integrator.

The power supply must comply with the following recommendations found in the indicated sections of the ATX form factor specification.

- The potential relation between 3.3 VDC and +5 VDC power rails (Section 4.2)
- The current capability of the +5 VSB line (Section 4.2.1.2)
- All timing parameters (Section 4.2.1.3)
- All voltage tolerances (Section 4.2.2)

For information about

The ATX form factor specification

Refer to

Section 1.3, page 16

2.12 Thermal Considerations



CAUTION

The use of an Intel Pentium 4 processor operating above 2.80 GHz with this Intel desktop board requires the following:

- *A chassis with appropriate airflow to ensure proper cooling of the components on the board*
- *A processor fan heatsink that meets the thermal performance targets for Pentium 4 processors operating above 2.80 GHz*

Failure to ensure appropriate airflow may result in reduced performance of both the processor and/or voltage regulator or, in some instances, damage to the desktop board. For a list of chassis that have been tested with Intel desktop boards please refer to the following website:

<http://developer.intel.com/design/motherbd/cooling.htm>

All responsibility for determining the adequacy of any thermal or system design remains solely with the reader. Intel makes no warranties or representations that merely following the instructions presented in this document will result in a system with adequate thermal performance.



CAUTION

Ensure that the ambient temperature does not exceed the Desktop Board's maximum operating temperature. Failure to do so could cause components to exceed their maximum case temperature and malfunction. For information about the maximum operating temperature, see the environmental specifications in Section 2.14.



CAUTION

Ensure that proper airflow is maintained in the processor voltage regulator circuit. Failure to do so may result in damage to the voltage regulator circuit. The processor voltage regulator area (item A in Figure 18) can reach a temperature of up to 85 °C in an open chassis.

Figure 18 shows the locations of the localized high temperature zones.

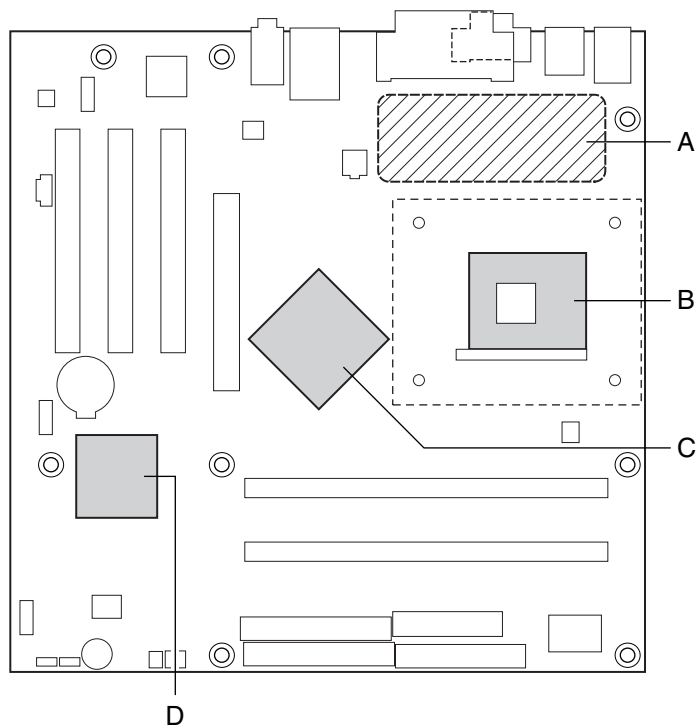

OM17041

Item	Description
A	Processor voltage regulator area
B	Processor
C	Intel 82865P MCH
D	Intel 82801EB ICH5

Figure 18. Localized High Temperature Zones

Table 32 provides maximum case temperatures for the Desktop Board D865PCD components that are sensitive to thermal changes. The operating temperature, current load, or operating frequency could affect case temperatures. Maximum case temperatures are important when considering proper airflow to cool the Desktop Board D865PCD.

Table 32. Thermal Considerations for Components

Component	Maximum Case Temperature
Intel Pentium 4 processor	For processor case temperature, see processor datasheets and processor specification updates
Intel 82865P MCH	99 °C (under bias)
Intel 82801EB ICH5	115 °C (under bias)

For information about	Refer to
Intel Pentium 4 processor datasheets and specification updates	Section 1.2, page 15

2.13 Reliability

The Mean Time Between Failures (MTBF) prediction is calculated using component and subassembly random failure rates. The calculation is based on the Bellcore Reliability Prediction Procedure, TR-NWT-000332, Issue 4, September 1991. The MTBF prediction is used to estimate repair rates and spare parts requirements.

The MTBF data is calculated from predicted data at 55 °C. The Desktop Board D865PCD MTBF is 101,425 hours.

2.14 Environmental

Table 33 lists the environmental specifications for the Desktop Board D865PCD.

Table 33. Desktop Board D865PCD Environmental Specifications

Parameter	Specification		
Temperature			
Non-Operating	-40 °C to +70 °C		
Operating	0 °C to +55 °C		
Shock			
Unpackaged	50 g trapezoidal waveform		
	Velocity change of 170 inches/second		
Packaged	Half sine 2 millisecond		
	Product Weight (pounds)	Free Fall (inches)	Velocity Change (inches/sec)
	<20	36	167
	21-40	30	152
	41-80	24	136
	81-100	18	118
Vibration			
Unpackaged	5 Hz to 20 Hz: 0.01 g ² Hz sloping up to 0.02 g ² Hz		
	20 Hz to 500 Hz: 0.02 g ² Hz (flat)		
Packaged	10 Hz to 40 Hz: 0.015 g ² Hz (flat)		
	40 Hz to 500 Hz: 0.015 g ² Hz sloping down to 0.00015 g ² Hz		

2.15 Regulatory Compliance

This section describes the Desktop Boards' compliance with U.S. and international safety and electromagnetic compatibility (EMC) regulations.

2.15.1 Safety Regulations

Table 34 lists the safety regulations the Desktop Board D865PCD complies with when correctly installed in a compatible host system.

Table 34. Safety Regulations

Regulation	Title
UL 60950 3rd ed.,2000/CSA C22.2 No. 60950-00	Bi-National Standard for Safety of Information Technology Equipment including Electrical Business Equipment. (USA and Canada)
EN 60950:2000	The Standard for Safety of Information Technology Equipment including Electrical Business Equipment. (European Union)
IEC 60950, 3 rd Edition, 1999	The Standard for Safety of Information Technology Equipment including Electrical Business Equipment. (International)

2.15.2 EMC Regulations

Table 35 lists the EMC regulations the Desktop Board D865PCD complies with when correctly installed in a compatible host system.

Table 35. EMC Regulations

Regulation	Title
FCC (Class B)	Title 47 of the Code of Federal Regulations, Parts 2 and 15, Subpart B, Radio Frequency Devices. (USA)
ICES-003 (Class B)	Interference-Causing Equipment Standard, Digital Apparatus. (Canada)
EN55022: 1998 (Class B)	Limits and methods of measurement of Radio Interference Characteristics of Information Technology Equipment. (European Union)
EN55024: 1998	Information Technology Equipment – Immunity Characteristics Limits and methods of measurement. (European Union)
AS/NZS 3548 (Class B)	Australian Communications Authority, Standard for Electromagnetic Compatibility. (Australia and New Zealand)
CISPR 22, 3 rd Edition (Class B)	Limits and methods of measurement of Radio Disturbance Characteristics of Information Technology Equipment. (International)
CISPR 24: 1997	Information Technology Equipment – Immunity Characteristics – Limits and Methods of Measurements. (International)

2.15.2.1 FCC Compliance Statement (USA)

Product Type: D865PCD Desktop Board

This device complies with Part 15 of the FCC Rules. Operation is subject to the following two conditions: (1) This device may not cause harmful interference, and (2) this device must accept any interference received, including interference that may cause undesired operation.

This equipment has been tested and found to comply with the limits for a Class B digital device, pursuant to Part 15 of the FCC Rules. These limits are designed to provide reasonable protection against harmful interference in a residential environment. This equipment generates, uses, and can radiate radio frequency energy and, if not installed and used in accordance with the instructions, may cause harmful interference to radio communications. However, there is no guarantee that interference will not occur in a particular installation. If this equipment does cause harmful interference to radio or television reception, which can be determined by turning the equipment off and on, the user is encouraged to try to correct the interference by one or more of the following measures:

- Reorient or relocate the receiving antenna.
- Increase the separation between the equipment and the receiver.
- Connect the equipment to a different electrical branch circuit from that to which the receiver is connected.
- Consult the dealer or an experienced radio/TV technician for help.

Any changes or modifications to the equipment not expressly approved by Intel Corporation could void the user's authority to operate the equipment.

2.15.2.2 Canadian Compliance Statement

This Class B digital apparatus complies with Canadian ICES-003.

Cet appareil numérique de la classe B est conforme à la norme NMB-003 du Canada.

2.15.3 European Union Declaration of Conformity Statement

We, Intel Corporation, declare under our sole responsibility that the product: Intel® Desktop Board D865PCD is in conformity with all applicable essential requirements necessary for CE marking, following the provisions of the European Council Directive 89/336/EEC (EMC Directive) and Council Directive 73/23/EEC (Safety/Low Voltage Directive).

The product is properly CE marked demonstrating this conformity and is for distribution within all member states of the EU with no restrictions.



This product follows the provisions of the European Directives 89/336/EEC and 73/23/EEC.

2.15.4 Product Ecology Statements

The following information is provided to address worldwide product ecology concerns and regulations.

2.15.4.1 Disposal Considerations

This product contains the following materials that may be regulated upon disposal: lead solder on the printed wiring board assembly.

2.15.4.2 Recycling Considerations

Intel encourages its customers to recycle its products and their components (e.g., batteries, circuit boards, plastic enclosures, etc.) whenever possible. In the U.S., a list of recyclers in your area can be found at:







<http://www.eiae.org/>

In the absence of a viable recycling option, products and their components must be disposed of in accordance with all applicable local environmental regulations.

2.15.5 Product Certification Markings (Board Level)

Table 36 lists the board’s product certification markings.

Table 36. Product Certification Markings

Description	Marking						
UL joint US/Canada Recognized Component mark. Includes adjacent UL file number for Intel Desktop Boards: E210882 (component side).							
FCC Declaration of Conformity logo mark for Class B equipment; includes Intel name and D865PCD model designation (component side).	<table border="1" data-bbox="1068 1136 1333 1276"> <tr> <td data-bbox="1079 1150 1166 1178">Trade Name</td> <td data-bbox="1170 1150 1321 1178">Model Number</td> </tr> <tr> <td colspan="2" data-bbox="1079 1184 1321 1255">  Tested To Comply With FCC Standards </td> </tr> <tr> <td colspan="2" data-bbox="1079 1241 1321 1276">FOR HOME OR OFFICE USE</td> </tr> </table>	Trade Name	Model Number	 Tested To Comply With FCC Standards		FOR HOME OR OFFICE USE	
Trade Name	Model Number						
 Tested To Comply With FCC Standards							
FOR HOME OR OFFICE USE							
CE mark. Declares compliance to European Union (EU) EMC directive (89/336/EEC) and Low Voltage directive (73/23/EEC) (component side). The CE mark should also be on the shipping container.							
Australian Communications Authority (ACA) C-Tick mark. Includes adjacent Intel supplier code number, N-232. The C-tick mark should also be on the shipping container.							
Printed wiring board manufacturer’s recognition mark: consists of a unique UL recognized manufacturer’s logo, along with a flammability rating (solder side).	94V-0						

3 Overview of BIOS Features

What This Chapter Contains

3.1	Introduction.....	69
3.2	BIOS Flash Memory Organization	69
3.3	Resource Configuration	70
3.4	System Management BIOS (SMBIOS)	71
3.5	Legacy USB Support	71
3.6	BIOS Updates	72
3.7	Recovering BIOS Data	73
3.8	Boot Options.....	74
3.9	Fast Booting Systems with Intel® Rapid BIOS Boot.....	75
3.10	BIOS Security Features.....	76

3.1 Introduction

The Desktop Board D865PCD uses an Intel/AMI BIOS that is stored in the Firmware Hub (FWH) and can be updated using a disk-based program. The FWH contains the BIOS Setup program, POST, the PCI auto-configuration utility, and Plug and Play support.

The BIOS displays a message during POST identifying the type of BIOS and a revision code. The initial production BIOSs are identified as RC86510A.86A.

When the BIOS Setup configuration jumper is set to configure mode and the computer is powered-up, the BIOS compares the CPU version and the microcode version in the BIOS and reports if the two match.

For information about	Refer to
The Desktop Boards' compliance level with Plug and Play	Section 1.3, page 16

3.2 BIOS Flash Memory Organization

The Firmware Hub (FWH) includes a 4 Mbit (512 KB) symmetrical flash memory device.

3.3 Resource Configuration

3.3.1 PCI Autoconfiguration

The BIOS can automatically configure PCI devices. PCI devices may be onboard or add-in cards. Autoconfiguration lets a user insert or remove PCI cards without having to configure the system. When a user turns on the system after adding a PCI card, the BIOS automatically configures interrupts, the I/O space, and other system resources. Any interrupts set to Available in Setup are considered to be available for use by the add-in card.

For information about	Refer to
The versions of PCI and Plug and Play supported by the BIOS	Section 1.3, page 16

3.3.2 PCI IDE Support

If you select Auto in the BIOS Setup program, the BIOS automatically sets up the two PCI IDE connectors with independent I/O channel support. The IDE interface supports hard drives up to ATA-66/100 and recognizes any ATAPI compliant devices, including CD-ROM drives, tape drives, and Ultra DMA drives (see Section 1.3 for the supported version of ATAPI). The BIOS determines the capabilities of each drive and configures them to optimize capacity and performance. To take advantage of the high capacities typically available today, hard drives are automatically configured for Logical Block Addressing (LBA) and to PIO Mode 3 or 4, depending on the capability of the drive. You can override the auto-configuration options by specifying manual configuration in the BIOS Setup program.

To use ATA-66/100 features the following items are required:

- An ATA-66/100 peripheral device
- An ATA-66/100 compatible cable
- ATA-66/100 operating system device drivers

NOTE

Do not connect an ATA device as a slave on the same IDE cable as an ATAPI master device. For example, do not connect an ATA hard drive as a slave to an ATAPI CD-ROM drive.

3.4 System Management BIOS (SMBIOS)

SMBIOS is a Desktop Management Interface (DMI) compliant method for managing computers in a managed network.

The main component of SMBIOS is the Management Information Format (MIF) database, which contains information about the computing system and its components. Using SMBIOS, a system administrator can obtain the system types, capabilities, operational status, and installation dates for system components. The MIF database defines the data and provides the method for accessing this information. The BIOS enables applications such as third-party management software to use SMBIOS. The BIOS stores and reports the following SMBIOS information:

- BIOS data, such as the BIOS revision level
- Fixed-system data, such as peripherals, serial numbers, and asset tags
- Resource data, such as memory size, cache size, and processor speed
- Dynamic data, such as event detection and error logging

Non-Plug and Play operating systems, such as Windows NT*, require an additional interface for obtaining the SMBIOS information. The BIOS supports an SMBIOS table interface for such operating systems. Using this support, an SMBIOS service-level application running on a non-Plug and Play operating system can obtain the SMBIOS information.

For information about

The Desktop Boards' compliance level with SMBIOS

Refer to

Section 1.3, page 16

3.5 Legacy USB Support

Legacy USB support enables USB devices such as keyboards, mice, and hubs to be used even when the operating system's USB drivers are not yet available. Legacy USB support is used to access the BIOS Setup program, and to install an operating system that supports USB. By default, Legacy USB support is set to Enabled.

Legacy USB support operates as follows:

1. When you apply power to the computer, legacy support is disabled.
2. POST begins.
3. Legacy USB support is enabled by the BIOS allowing you to use a USB keyboard to enter and configure the BIOS Setup program and the maintenance menu.
4. POST completes.
5. The operating system loads. While the operating system is loading, USB keyboards and mice are recognized and may be used to configure the operating system. (Keyboards and mice are not recognized during this period if Legacy USB support was set to Disabled in the BIOS Setup program.)
6. After the operating system loads the USB drivers, all legacy and non-legacy USB devices are recognized by the operating system, and Legacy USB support from the BIOS is no longer used.

To install an operating system that supports USB, verify that Legacy USB support in the BIOS Setup program is set to Enabled and follow the operating system's installation instructions.

 **NOTE**

Legacy USB support is for keyboards, mice, and hubs only. Other USB devices are not supported in legacy mode.

3.6 BIOS Updates

The BIOS can be updated using either of the following utilities, which are available on the Intel World Wide Web site:

- Intel® Express BIOS Update utility, which enables automated updating while in the Windows environment. Using this utility, the BIOS can be updated from a file on a hard disk, a 1.44 MB diskette, or a CD-ROM, or from the file location on the Web.
- Intel® Flash Memory Update Utility, which requires creation of a boot diskette and manual rebooting of the system. Using this utility, the BIOS can be updated from a file on a 1.44 MB diskette (from a legacy diskette drive or an LS-120 diskette drive) or a CD-ROM.

Both utilities support the following BIOS maintenance functions:

- Verifying that the updated BIOS matches the target system to prevent accidentally installing an incompatible BIOS.
- Updating both the BIOS boot block and the main BIOS. This process is fault tolerant to prevent boot block corruption.
- Updating the BIOS boot block separately.
- Changing the language section of the BIOS.
- Updating replaceable BIOS modules, such as the video BIOS module.
- Inserting a custom splash screen.

 **NOTE**

Review the instructions distributed with the upgrade utility before attempting a BIOS update.

For information about	Refer to
The Intel World Wide Web site	Section 1.2, page 15

3.6.1 Language Support

The BIOS Setup program and help messages are supported in five languages: US English, German, Italian, French, and Spanish. The default language is US English, which is present unless another language is selected in the BIOS Setup program.

3.6.2 Custom Splash Screen

During POST, an Intel® splash screen is displayed by default. This splash screen can be augmented with a custom splash screen. A utility is available from Intel to assist with creating a custom splash screen. The custom splash screen can be programmed into the flash memory using the BIOS upgrade utility. Information about this capability is available on the Intel Support World Wide Web site.

NOTE

If you add a custom splash screen, it will share space with the Intel branded logo.

For information about	Refer to
The Intel World Wide Web site	Section 1.2, page 15

3.7 Recovering BIOS Data

Some types of failure can destroy the BIOS. For example, the data can be lost if a power outage occurs while the BIOS is being updated in flash memory. The BIOS can be recovered from a diskette using the BIOS recovery mode. When recovering the BIOS, be aware of the following:

- Because of the small amount of code available in the non-erasable boot block area, there is no video support. You can only monitor this procedure by listening to the speaker or looking at the diskette drive LED.
- The recovery process may take several minutes; larger BIOS flash memory devices require more time.
- Two beeps and the end of activity in the diskette drive indicate successful BIOS recovery.
- A series of continuous beeps indicates a failed BIOS recovery.

To create a BIOS recovery diskette, a bootable diskette must be created and the BIOS update files copied to it. BIOS upgrades and the Intel Flash Memory Update Utility are available from Intel Customer Support through the Intel World Wide Web site.

NOTE

Even if the computer is configured to boot from an LS-120 diskette (in the Setup program's Removable Devices submenu), the BIOS recovery diskette must be a standard 1.44 MB diskette not a 120 MB diskette.

For information about	Refer to
The BIOS recovery mode jumper settings	Section 2.9.2, page 57
The Boot menu in the BIOS Setup program	Section 4.7, page 96
Contacting Intel customer support	Section 1.2, page 15

3.8 Boot Options

In the BIOS Setup program, the user can choose to boot from a diskette drive, hard drives, CD-ROM, or the network. The default setting is for the diskette drive to be the first boot device, the hard drive second, and the ATAPI CD-ROM third. The fourth device is disabled.

3.8.1 CD-ROM Boot

Booting from CD-ROM is supported in compliance to the El Torito bootable CD-ROM format specification. Under the Boot menu in the BIOS Setup program, ATAPI CD-ROM is listed as a boot device. Boot devices are defined in priority order. Accordingly, if there is not a bootable CD in the CD-ROM drive, the system will attempt to boot from the next defined drive.

For information about	Refer to
The El Torito specification	Section 1.3, page 16

3.8.2 Network Boot

The network can be selected as a boot device. This selection allows booting from the onboard LAN or a network add-in card with a remote boot ROM installed.

Pressing the <F12> key during POST automatically forces booting from the LAN. To use this key during POST, the User Access Level in the BIOS Setup program's Security menu must be set to Full.

For information about	Refer to
The BIOS Setup program's Security menu	Table 54, page 94

3.8.3 Booting Without Attached Devices

For use in embedded applications, the BIOS has been designed so that after passing the POST, the operating system loader is invoked even if the following devices are not present:

- Video adapter
- Keyboard
- Mouse

3.8.4 Changing the Default Boot Device During POST

Pressing the <F10> key during POST causes a boot device menu to be displayed. This menu displays the list of available boot devices (as set in the BIOS setup program's Boot Device Priority Submenu). Table 37 lists the boot device menu options.

Table 37. Boot Device Menu Options

Boot Device Menu Function Keys	Description
<↑> or <↓>	Selects a default boot device
<Enter>	Exits the menu, saves changes, and boots from the selected device
<Esc>	Exits the menu without saving changes

3.9 Fast Booting Systems with Intel® Rapid BIOS Boot

These factors affect system boot speed:

- Selecting and configuring peripherals properly
- Using an optimized BIOS, such as the Intel® Rapid BIOS

3.9.1 Peripheral Selection and Configuration

The following techniques help improve system boot speed:

- Choose a hard drive with parameters such as “power-up to data ready” less than eight seconds, that minimize hard drive startup delays.
- Select a CD-ROM drive with a fast initialization rate. This rate can influence POST execution time.
- Eliminate unnecessary add-in adapter features, such as logo displays, screen repaints, or mode changes in POST. These features may add time to the boot process.
- Try different monitors. Some monitors initialize and communicate with the BIOS more quickly, which enables the system to boot more quickly.

3.9.2 Intel Rapid BIOS Boot

Use of the following BIOS Setup program settings reduces the POST execution time.

In the Boot Menu:

- Set the hard disk drive as the first boot device. As a result, the POST does not first seek a diskette drive, which saves about one second from the POST execution time.
- Disable Quiet Boot, which eliminates display of the logo splash screen. This could save several seconds of painting complex graphic images and changing video modes.
- Enable Intel Rapid BIOS Boot. This feature bypasses memory count and the search for a diskette drive.

In the Peripheral Configuration submenu, disable the LAN device if it will not be used. This can reduce up to four seconds of option ROM boot time.

NOTE

It is possible to optimize the boot process to the point where the system boots so quickly that the Intel logo screen (or a custom logo splash screen) will not be seen. Monitors and hard disk drives with minimum initialization times can also contribute to a boot time that might be so fast that necessary logo screens and POST messages cannot be seen.

This boot time may be so fast that some drives might be not be initialized at all. If this condition should occur, it is possible to introduce a programmable delay ranging from three to 30 seconds (using the Hard Disk Pre-Delay feature of the Advanced Menu in the Drive Configuration Submenu of the BIOS Setup program).

For information about

Drive Configuration Submenu in the BIOS Setup program

Refer to

Section 4.4.4, page 85

3.10 BIOS Security Features

The BIOS includes security features that restrict access to the BIOS Setup program and who can boot the computer. A supervisor password and a user password can be set for the BIOS Setup program and for booting the computer, with the following restrictions:

- The supervisor password gives unrestricted access to view and change all the Setup options in the BIOS Setup program. This is the supervisor mode.
- The user password gives restricted access to view and change Setup options in the BIOS Setup program. This is the user mode.
- If only the supervisor password is set, pressing the <Enter> key at the password prompt of the BIOS Setup program allows the user restricted access to Setup.
- If both the supervisor and user passwords are set, users can enter either the supervisor password or the user password to access Setup. Users have access to Setup respective to which password is entered.
- Setting the user password restricts who can boot the computer. The password prompt will be displayed before the computer is booted. If only the supervisor password is set, the computer boots without asking for a password. If both passwords are set, the user can enter either password to boot the computer.

Table 38 shows the effects of setting the supervisor password and user password. This table is for reference only and is not displayed on the screen.

Table 38. Supervisor and User Password Functions

Password Set	Supervisor Mode	User Mode	Setup Options	Password to Enter Setup	Password During Boot
Neither	Can change all options <small>(Note)</small>	Can change all options <small>(Note)</small>	None	None	None
Supervisor only	Can change all options	Can change a limited number of options	Supervisor Password	Supervisor	None
User only	N/A	Can change all options	Enter Password Clear User Password	User	User
Supervisor and user set	Can change all options	Can change a limited number of options	Supervisor Password Enter Password	Supervisor or user	Supervisor or user

Note: If no password is set, any user can change all Setup options.

For information about

Setting user and supervisor passwords

Refer to

Section 4.5, page 94

NOTES

- *For enhanced security, use different passwords for the supervisor and user passwords.*
- *Valid password characters are A-Z, a-z, and 0-9.*

4 BIOS Setup Program

What This Chapter Contains

4.1	Introduction.....	77
4.2	Maintenance Menu	78
4.3	Main Menu.....	79
4.4	Advanced Menu.....	80
4.5	Security Menu	94
4.6	Power Menu	95
4.7	Boot Menu	96
4.8	Exit Menu	99

4.1 Introduction

The BIOS Setup program can be used to view and change the BIOS settings for the computer. The BIOS Setup program is accessed by pressing the <F2> key after the Power-On Self-Test (POST) memory test begins and before the operating system boot begins. The menu bar is shown below.

Maintenance	Main	Advanced	Security	Power	Boot	Exit
-------------	------	----------	----------	-------	------	------

Table 39 lists the BIOS Setup program menu features.

Table 39. BIOS Setup Program Menu Bar

Maintenance	Main	Advanced	Security	Power	Boot	Exit
Clears passwords and displays processor information	Displays processor and memory configuration	Configures advanced features available through the chipset	Sets passwords and security features	Configures power management features and power supply controls	Selects boot options	Saves or discards changes to Setup program options

 **NOTE**

In this chapter, all examples of the BIOS Setup program menu bar include the maintenance menu; however, the maintenance menu is displayed only when the Desktop Board is in configure mode. Section 2.9.2 on page 57 tells how to put the Desktop Board in configure mode.

Table 40 lists the function keys available for menu screens.

Table 40. BIOS Setup Program Function Keys

BIOS Setup Program Function Key	Description
<←> or <→>	Selects a different menu screen (Moves the cursor left or right)
<↑> or <↓>	Selects an item (Moves the cursor up or down)
<Tab>	Selects a field (Not implemented)
<Enter>	Executes command or selects the submenu
<F9>	Load the default configuration values for the current menu
<F10>	Save the current values and exits the BIOS Setup program
<Esc>	Exits the menu

4.2 Maintenance Menu

To access this menu, select Maintenance on the menu bar at the top of the screen.

Maintenance	Main	Advanced	Security	Power	Boot	Exit
--------------------	------	----------	----------	-------	------	------

The menu shown in Table 41 is for clearing Setup passwords and displaying processor information. Setup only displays this menu in configure mode. See Section 2.9.2 on page 57 for configure mode setting information.

Table 41. Maintenance Menu

Feature	Options	Description
Clear All Passwords	<ul style="list-style-type: none"> • Ok (default) • Cancel 	Clears the user and supervisor passwords.
CPU Stepping Signature	No options	Displays CPU's Stepping Signature.
CPU Microcode Update Revision	No options	Displays CPU's Microcode Update Revision.

4.3 Main Menu

To access this menu, select Main on the menu bar at the top of the screen.

Maintenance	Main	Advanced	Security	Power	Boot	Exit
-------------	-------------	----------	----------	-------	------	------

Table 42 describes the Main menu. This menu reports processor and memory information and is for configuring the system date and system time.

Table 42. Main Menu

Feature	Options	Description
BIOS Version	No options	Displays the version of the BIOS.
Processor Type	No options	Displays processor type.
Hyper-Threading Technology	<ul style="list-style-type: none"> • Disabled • Enabled (default) 	Disables/enables Hyper-Threading Technology. This option is present only when a processor that supports Hyper-Threading Technology is installed.
Processor Speed	No options	Displays processor speed.
System Bus Speed	No options	Displays the system bus speed.
System Memory Speed	No options	Displays the system memory speed.
L2 Cache RAM	No options	Displays the size of second-level cache.
Total Memory	No options	Displays the total amount of RAM.
Memory Mode	No options	Displays the memory mode (Dual Channel or Single Channel).
Memory Channel A Slot 0 Memory Channel B Slot 0	No options	Displays the amount and type of RAM in the DIMM sockets.
Language	<ul style="list-style-type: none"> • English (default) • Francais 	Selects the current default language used by the BIOS.
System Time	Hour, minute, and second	Specifies the current time.
System Date	Day of week Month/day/year	Specifies the current date.

4.4 Advanced Menu

To access this menu, select Advanced on the menu bar at the top of the screen.

Maintenance	Main	Advanced	Security	Power	Boot	Exit
		PCI Configuration				
		Boot Configuration				
		Peripheral Configuration				
		Drive Configuration				
		Floppy Configuration				
		Event Log Configuration				
		Video Configuration				
		USB Configuration				
		Chipset Configuration				

Table 43 describes the Advanced Menu. This menu is used for setting advanced features that are available through the chipset.

Table 43. Advanced Menu

Feature	Options	Description
PCI Configuration	Select to display submenu	Configures individual PCI slot's IRQ priority.
Boot Configuration	Select to display submenu	Configures Plug and Play and the Numlock key, and resets configuration data.
Peripheral Configuration	Select to display submenu	Configures peripheral ports and devices.
Drive Configuration	Select to display submenu	Specifies type of connected IDE devices.
Floppy Configuration	Select to display submenu	Configures the diskette drive.
Event Log Configuration	Select to display submenu	Configures Event Logging.
Video Configuration	Select to display submenu	Configures video features.
USB Configuration	Select to display submenu	Configures USB support.
Chipset Configuration	Select to display submenu	Configures advanced chipset features.

4.4.1 PCI Configuration Submenu

To access this submenu, select Advanced on the menu bar and then PCI Configuration.

Maintenance	Main	Advanced	Security	Power	Boot	Exit
		PCI Configuration				
		Boot Configuration				
		Peripheral Configuration				
		Drive Configuration				
		Floppy Configuration				
		Event Log Configuration				
		Video Configuration				
		USB Configuration				
		Chipset Configuration				

The submenu shown in Table 44 is used to configure the IRQ priority of PCI slots individually.

Table 44. PCI Configuration Submenu

Feature	Options	Description
PCI Slot1 IRQ Priority (Note)	<ul style="list-style-type: none"> • Auto (default) • 3 • 5 • 9 • 10 • 11 	Allows selection of IRQ priority for PCI bus connector 1.
PCI Slot2 IRQ Priority (Note)	<ul style="list-style-type: none"> • Auto (default) • 3 • 5 • 9 • 10 • 11 	Allows selection of IRQ priority for PCI bus connector 2.
PCI Slot3 IRQ Priority (Note)	<ul style="list-style-type: none"> • Auto (default) • 3 • 5 • 9 • 10 • 11 	Allows selection of IRQ priority for PCI bus connector 3.

Note: Additional interrupts may be available if certain onboard devices (such as the serial and parallel ports) are disabled.

4.4.2 Boot Configuration Submenu

To access this submenu, select Advanced on the menu bar and then Boot Configuration.

Maintenance	Main	Advanced	Security	Power	Boot	Exit
		PCI Configuration				
		Boot Configuration				
		Peripheral Configuration				
		Drive Configuration				
		Floppy Configuration				
		Event Log Configuration				
		Video Configuration				
		USB Configuration				
		Chipset Configuration				

The submenu represented by Table 45 is for setting Plug and Play options and the power-on state of the Numlock key.

Table 45. Boot Configuration Submenu

Feature	Options	Description
Plug & Play O/S	<ul style="list-style-type: none"> No (default) Yes 	<p>Specifies if manual configuration is desired.</p> <p><i>No</i> lets the BIOS configure all devices. This setting is appropriate when using a Plug and Play operating system.</p> <p><i>Yes</i> lets the operating system configure Plug and Play devices not required to boot the system. This option is available for use during lab testing.</p>
Numlock	<ul style="list-style-type: none"> Off On (default) 	<p>Specifies the power-on state of the Numlock feature on the numeric keypad of the keyboard.</p>

4.4.3 Peripheral Configuration Submenu

To access this submenu, select **Advanced** on the menu bar and then **Peripheral Configuration**.

Maintenance	Main	Advanced	Security	Power	Boot	Exit
		PCI Configuration				
		Boot Configuration				
		Peripheral Configuration				
		Drive Configuration				
		Floppy Configuration				
		Event Log Configuration				
		Video Configuration				
		USB Configuration				
		Chipset Configuration				

The submenu represented in Table 46 is used for configuring computer peripherals.

Table 46. Peripheral Configuration Submenu

Feature	Options	Description
Serial Port A	<ul style="list-style-type: none"> • Disabled • Enabled • Auto (default) 	<p>Configures serial port A.</p> <p><i>Auto</i> assigns the first free COM port, normally COM1, the address 3F8h, and the interrupt IRQ4.</p> <p>An * (asterisk) displayed next to an address indicates a conflict with another device.</p>
Base I/O address (This feature is present only when Serial Port A is set to <i>Enabled</i>)	<ul style="list-style-type: none"> • 3F8 (default) • 2F8 • 3E8 • 2E8 	<p>Specifies the base I/O address for serial port A, if serial port A is set to <i>Enabled</i>.</p>
Interrupt (This feature is present only when Serial Port A is set to <i>Enabled</i>)	<ul style="list-style-type: none"> • IRQ 3 • IRQ 4 (default) 	<p>Specifies the interrupt for serial port A, if serial port A is set to <i>Enabled</i>.</p>

continued

Table 46. Peripheral Configuration Submenu (continued)

Feature	Options	Description
Parallel port	<ul style="list-style-type: none"> Disabled Enabled Auto (default) 	Configures the parallel port. <i>Auto</i> assigns LPT1 the address 378h and the interrupt IRQ7. An * (asterisk) displayed next to an address indicates a conflict with another device.
Mode	<ul style="list-style-type: none"> Output Only Bi-directional (default) EPP ECP 	Selects the mode for the parallel port. Not available if the parallel port is disabled. <i>Output Only</i> operates in AT*-compatible mode. <i>Bi-directional</i> operates in PS/2-compatible mode. <i>EPP</i> is Extended Parallel Port mode, a high-speed bi-directional mode. <i>ECP</i> is Enhanced Capabilities Port mode, a high-speed bi-directional mode.
Base I/O address (This feature is present only when Parallel Port is set to <i>Enabled</i>)	<ul style="list-style-type: none"> 378 (default) 278 	Specifies the base I/O address for the parallel port.
Interrupt (This feature is present only when Parallel Port is set to <i>Enabled</i>)	<ul style="list-style-type: none"> IRQ 5 IRQ 7 (default) 	Specifies the interrupt for the parallel port.
DMA (This feature is present only when Parallel Port Mode is set to <i>ECP</i>)	<ul style="list-style-type: none"> 1 3 (default) 	Specifies the DMA channel.
Audio	<ul style="list-style-type: none"> Enabled (default) Disabled 	Enables or disables the onboard audio subsystem.
Onboard LAN	<ul style="list-style-type: none"> Enabled (default) Disabled 	Enables or disables the onboard LAN device.
ASF Support	<ul style="list-style-type: none"> Disabled Enabled (default) 	Enables or disables ASF (Alert Standard Format) support.

4.4.4 Drive Configuration Submenu

To access this submenu, select Advanced on the menu bar and then Drive Configuration.

Maintenance	Main	Advanced	Security	Power	Boot	Exit
		PCI Configuration				
		Boot Configuration				
		Peripheral Configuration				
		Drive Configuration				
		Floppy Configuration				
		Event Log Configuration				
		Video Configuration				
		USB Configuration				
		Chipset Configuration				

The menu represented in Table 47 is used to configure IDE device options.

Table 47. Drive Configuration Submenu

Feature	Options	Description
PCI IDE Bus Master	<ul style="list-style-type: none"> • Disabled • Enabled (default) 	Enables/disables the use of DMA for hard drive BIOS INT13 reads and writes.
Hard Disk Pre-Delay	<ul style="list-style-type: none"> • Disabled (default) • 1 Second • 2 Seconds • 3 Seconds • 4 Seconds • 5 Seconds • 6 Seconds • 9 Seconds • 12 Seconds • 15 Seconds • 21 Seconds • 30 Seconds 	Specifies the hard disk drive pre-delay.
SATA Port-0	None	Not supported
SATA Port-1	None	Not supported
PATA Primary Master	Select to display sub-menu	Reports type of connected device on Parallel ATA (PATA) IDE primary master interface.
PATA Primary Slave	Select to display sub-menu	Reports type of connected device on Parallel ATA (PATA) IDE primary slave interface.
PATA Secondary Master	Select to display sub-menu	Reports type of connected device on Parallel ATA (PATA) IDE secondary master interface.
PATA Secondary Slave	Select to display sub-menu	Reports type of connected device on Parallel ATA (PATA) IDE secondary slave interface.

continued

4.4.4.1 PATA Submenus

To access these submenus, select Advanced on the menu bar, then Drive Configuration, and then the master or slave to be configured.

Maintenance	Main	Advanced	Security	Power	Boot	Exit
		PCI Configuration				
		Boot Configuration				
		Peripheral Configuration				
		Drive Configuration				
		SATA Port-0				
		SATA Port-1				
		PATA Primary Master				
		PATA Primary Slave				
		PATA Secondary Master				
		PATA Secondary Slave				
		Floppy Configuration				
		Event Log Configuration				
		Video Configuration				
		USB Configuration				
		Chipset Configuration				

There are four available submenus in this screen:

- PATA primary master
- PATA primary slave
- PATA secondary master
- PATA secondary slave

Table 48 on page 87 shows the format of the PATA IDE submenus. For brevity, only one example is shown.

 **NOTE**

SATA support is not present on the Desktop Board D865PCD. The SATA submenus in this BIOS screen are not accessible.

Table 48. PATA Submenus

Feature	Options	Description
Drive Installed	No options	Displays the type of drive installed.
Type	<ul style="list-style-type: none"> • Auto (default) • User 	Specifies the IDE configuration mode for IDE devices. <i>User</i> allows capabilities to be changed. <i>Auto</i> fills-in capabilities from ATA/ATAPI device.
Maximum Capacity	No options	Displays the drive capacity.
LBA/Large Mode	<ul style="list-style-type: none"> • Disabled • Auto (default) 	Displays whether automatic translation mode is enabled for the hard disk. (This item is read-only unless Type is set to <i>User</i> .)
Block Mode	<ul style="list-style-type: none"> • Disabled • Auto (default) 	Displays whether automatic multiple sector data transfers are enabled. (This item is read-only unless Type is set to <i>User</i> .)
PIO Mode	Auto (default) 0 1 2 3 4	Sets the PIO mode. (This item is read-only unless Type is set to <i>User</i> .)
DMA Mode	<ul style="list-style-type: none"> • Auto (default) • SWDMA0 • SWDMA1 • SWDMA2 • MWDMA0 • MWDMA1 • MWDMA2 • UDMA0 • UDMA1 • UDMA2 	Specifies the DMA mode for the drive. <i>Auto</i> = Auto-detected <i>SWDMA_n</i> = Single Word DMA _n <i>SWDMA_n</i> = Multi Word DMA _n <i>UDMA_n</i> = Ultra DMA _n (This item is read-only unless Type is set to <i>User</i> .)
S.M.A.R.T.	<ul style="list-style-type: none"> • Auto (default) • Disabled • Enabled 	Enables/disables S.M.A.R.T. (Self-Monitoring, Analysis, and Reporting Technology). (This item is read-only unless Type is set to <i>User</i> .)
Cable Detected	No options	Displays the type of cable connected to the IDE interface: 40-conductor or 80-conductor (for ATA-100 peripherals).

Note: If an LS-120 drive is attached to the system, a row entitled ARMD Emulation Type will be displayed in the above table. The BIOS will always recognize the drive as an ATAPI floppy drive. The ARMD Emulation Type should always be set to Floppy.

4.4.5 Floppy Configuration Submenu

To access this menu, select Advanced on the menu bar and then Floppy Configuration.

Maintenance	Main	Advanced	Security	Power	Boot	Exit
		PCI Configuration				
		Boot Configuration				
		Peripheral Configuration				
		Drive Configuration				
		Floppy Configuration				
		Event Log Configuration				
		Video Configuration				
		USB Configuration				
		Chipset Configuration				

The submenu represented by Table 49 is used for configuring the diskette drive.

Table 49. Floppy Configuration Submenu

Feature	Options	Description
Diskette Controller	<ul style="list-style-type: none"> Disabled Enabled (default) 	Disables or enables the integrated diskette controller.
Floppy A	<ul style="list-style-type: none"> Disabled 360 KB 5¼" 1.2 MB 5¼" 720 KB 3½" 1.44 MB 3½" (default) 2.88 MB 3½" 	Specifies the capacity and physical size of diskette drive A.
Diskette Write Protect	<ul style="list-style-type: none"> Disabled (default) Enabled 	Disables or enables write protection for the diskette drive.

4.4.6 Event Log Configuration Submenu

To access this menu, select Advanced on the menu bar and then Event Log Configuration.

Maintenance	Main	Advanced	Security	Power	Boot	Exit
		PCI Configuration				
		Boot Configuration				
		Peripheral Configuration				
		Drive Configuration				
		Floppy Configuration				
		Event Log Configuration				
		Video Configuration				
		USB Configuration				
		Chipset Configuration				

The submenu represented by Table 50 is used to configure the event logging features.

Table 50. Event Log Configuration Submenu

Feature	Options	Description
Event Log	No options	Indicates if there is space available in the event log.
View Event Log	[Enter]	Displays the event log.
Clear Event Log	<ul style="list-style-type: none"> • Ok (default) • Cancel 	Clears the event log after rebooting.
Event Logging	<ul style="list-style-type: none"> • Disabled • Enabled (default) 	Enables/disables logging of DMI events.
Mark Events As Read	<ul style="list-style-type: none"> • Ok (default) • Cancel 	Marks all events as read.

4.4.7 Video Configuration Submenu

To access this menu, select Advanced on the menu bar and then Video Configuration.

Maintenance	Main	Advanced	Security	Power	Boot	Exit
		PCI Configuration				
		Boot Configuration				
		Peripheral Configuration				
		Drive Configuration				
		Floppy Configuration				
		Event Log Configuration				
		Video Configuration				
		USB Configuration				
		Chipset Configuration				

The submenu represented in Table 51 is for configuring the video features.

Table 51. Video Configuration Submenu

Feature	Options	Description
AGP Aperture Size	<ul style="list-style-type: none"> • 4 MB • 8 MB • 16 MB • 32 MB • 64 MB (default) • 128 MB • 256 MB 	Sets the aperture size for the video controller.
Primary Video Adapter	<ul style="list-style-type: none"> • AGP (default) • PCI 	Selects primary video adapter to be used during boot.

4.4.8 USB Configuration Submenu

To access this menu, select Advanced on the menu bar and then USB Configuration.

Maintenance	Main	Advanced	Security	Power	Boot	Exit
		PCI Configuration				
		Boot Configuration				
		Peripheral Configuration				
		Drive Configuration				
		Floppy Configuration				
		Event Log Configuration				
		Video Configuration				
		USB Configuration				
		Chipset Configuration				

The submenu represented in Table 52 is for configuring the USB features.

Table 52. USB Configuration Submenu

Feature	Options	Description
High-Speed USB	<ul style="list-style-type: none"> • Enabled (default) • Disabled 	Set to <i>Disabled</i> when a USB 2.0 driver is not available.
Legacy USB Support	<ul style="list-style-type: none"> • Disabled • Enabled (default) 	Enables/disables legacy USB support.
USB 2.0 Legacy Support	<ul style="list-style-type: none"> • Full-Speed (default) • Hi-Speed 	Configures the USB 2.0 Legacy support to Hi-Speed (480 Mbps) or Full-Speed (12 Mbps).

4.4.9 Chipset Configuration Submenu

To access this menu, select Advanced on the menu bar and then Chipset Configuration.

Maintenance	Main	Advanced	Security	Power	Boot	Exit
		PCI Configuration				
		Boot Configuration				
		Peripheral Configuration				
		Drive Configuration				
		Floppy Configuration				
		Event Log Configuration				
		Video Configuration				
		USB Configuration				
		Chipset Configuration				

The submenu represented in Table 53 is for configuring chipset options.

Table 53. Chipset Configuration Submenu

Feature	Options	Description
ISA Enable Bit	<ul style="list-style-type: none"> Disabled Enabled (default) 	When set to <i>Enable</i> , a PCI-to-PCI bridge will only recognize I/O addresses that do not alias to an ISA range (within the bridge's assigned I/O range).
PCI Latency Timer	<ul style="list-style-type: none"> 32 (default) 64 96 128 160 192 224 248 	Allows you to control the time (in PCI bus clock cycles) that an agent on the PC bus can hold the bus when another agent has requested the bus.
Extended Configuration	<ul style="list-style-type: none"> Default (default) User Defined 	Allows the setting of extended configuration options.
SDRAM Frequency (Note 1)	<ul style="list-style-type: none"> Auto (default) 266 MHz 333 MHz (Note 2) 	Allows override of the detected memory frequency. NOTE: If SDRAM Frequency is changed, you must reboot for the change to take effect. After changing this setting and rebooting, the System Memory Speed parameter in the Main menu will reflect the new value.

continued

Table 53. Chipset Configuration Submenu (continued)

Feature	Options	Description
CPC Override	<ul style="list-style-type: none"> • Auto (default) • Enabled • Disabled 	Controls the CPC/1n rule mode. <i>Enabled</i> allows the DRAM controller to attempt chip select assertions in two consecutive common clocks.
SDRAM Timing Control (Note 1)	<ul style="list-style-type: none"> • Auto (default) • Manual – Aggressive • Manual – User Defined 	<i>Auto</i> = Timings will be programmed according to the memory detected. <i>Manual – Aggressive</i> = Selects most aggressive user-defined timings. <i>Manual – User Defined</i> = Allows manual override of detected SDRAM settings.
SDRAM RAS Active to Precharge (Note 3)	<ul style="list-style-type: none"> • 8 • 7 • 6 (default) • 5 	Corresponds to tRAS.
SDRAM CAS# Latency (Note 3)	<ul style="list-style-type: none"> • 2.0 • 2.5 (default) • 3.0 	Selects the number of clock cycles required to address a column in memory.
SDRAM RAS# to CAS# Delay (Note 3)	<ul style="list-style-type: none"> • 4 • 3 (default) • 2 	Selects the number of clock cycles between addressing a row and addressing a column.
SDRAM RAS# Precharge (Note 3)	<ul style="list-style-type: none"> • 4 • 3 (default) • 2 	Selects the length of time required before accessing a new row.

Notes:

1. This feature is displayed only if Extended Configuration is set to User Defined.
2. This option is displayed only if the installed processor has a 533 MHz system bus.
3. This feature is displayed only if SDRAM Timing Control is set to Manual – User Defined.

4.5 Security Menu

To access this menu, select Security from the menu bar at the top of the screen.

Maintenance	Main	Advanced	Security	Power	Boot	Exit
-------------	------	----------	-----------------	-------	------	------

The menu represented by Table 54 is for setting passwords and security features.

Table 54. Security Menu

If no password entered previously:		
Feature	Options	Description
Supervisor Password	No options	Reports if there is a supervisor password set.
User Password	No options	Reports if there is a user password set.
Set Supervisor Password	Password can be up to seven alphanumeric characters. (Note 1)	Specifies the supervisor password.
User Access Level (Note 2)	<ul style="list-style-type: none"> • No Access • View Only • Limited • Full (default) 	<p>Sets the user access rights to the BIOS Setup Utility.</p> <p><i>No Access</i> prevents user access to the BIOS Setup Utility.</p> <p><i>View Only</i> allows the user to view but not change the BIOS Setup Utility fields.</p> <p><i>Limited</i> allows the user to changes some fields.</p> <p><i>Full</i> allows the user to changes all fields except the supervisor password.</p>
Set User Password	Password can be up to seven alphanumeric characters. (Note 1)	Specifies the user password.
Clear User Password (Note 3)	<ul style="list-style-type: none"> • Ok (default) • Cancel 	Clears the user password.
Chassis Intrusion	<ul style="list-style-type: none"> • Disabled (default) • Log • Log, notify once • Log, notify until cleared 	<p><i>Disabled</i> = Disables Chassis Intrusion</p> <p><i>Log</i> = Logs the intrusion in the event log</p> <p><i>Log, notify once</i> = Halts system during POST. User must press <F4> to continue. Intrusion flag is cleared and the event log is updated.</p> <p><i>Log, notify til cleared</i> = Halts system during POST. User must enter BIOS setup Security Menu and select "Clear Chassis Intrusion Status" to clear the Chassis intrusion flag.</p>

Notes:

1. Valid password characters are A-Z, a-z, and 0-9.
2. This feature is displayed only if a supervisor password has been set.
3. This feature is displayed only if a user password has been set.

4.6 Power Menu

To access this menu, select Power from the menu bar at the top of the screen.

Maintenance	Main	Advanced	Security	Power	Boot	Exit
				ACPI		

The menu represented in Table 55 is for setting the power management features.

Table 55. Power Menu

Feature	Options	Description
ACPI	Select to display submenu	Sets the ACPI power management options.
After Power Failure	<ul style="list-style-type: none"> Stay Off Last State (default) Power On 	<p>Specifies the mode of operation if an AC power loss occurs.</p> <p><i>Stay Off</i> keeps the power off until the power button is pressed.</p> <p><i>Last State</i> restores the previous power state before power loss occurred.</p> <p><i>Power On</i> restores power to the computer.</p>
Wake on PCI PME	<ul style="list-style-type: none"> Stay Off (default) Power On 	Specifies how the computer responds to a PCI power management event.

4.6.1 ACPI Submenu

To access this menu, select Power from the menu bar at the top of the screen and then ACPI.

Maintenance	Main	Advanced	Security	Power	Boot	Exit
				ACPI		

The submenu represented in Table 56 is for setting the ACPI power options.

Table 56. ACPI Submenu

Feature	Options	Description
ACPI Suspend State	<ul style="list-style-type: none"> S1 State S3 State (default) 	<p>S1 is the safest mode but consumes more power. S3 consumes less power, but some drivers may not support this state.</p>
Wake on LAN* from S5	<ul style="list-style-type: none"> Stay Off (default) Power On 	In ACPI soft-off mode only, determines how the system responds to a LAN wake-up event.

4.7 Boot Menu

To access this menu, select Boot from the menu bar at the top of the screen.

Maintenance	Main	Advanced	Security	Power	Boot	Exit
					Boot Device Priority	
					Hard Disk Drives	
					Removable Devices	
					ATAPI CD-ROM Drives	

The menu represented in Table 57 is used to set the boot features and the boot sequence.

Table 57. Boot Menu

Feature	Options	Description
Silent Boot	<ul style="list-style-type: none"> Disabled Enabled (default) 	<p><i>Disabled</i> displays normal POST messages.</p> <p><i>Enabled</i> displays OEM graphic instead of POST messages.</p>
Intel(R) Rapid BIOS Boot	<ul style="list-style-type: none"> Disabled Enabled (default) 	Enables the computer to boot without running certain POST tests.
Boot from Network	<ul style="list-style-type: none"> Disabled (default) Enabled 	<p>Disables/enables PXE boot to LAN.</p> <p>Note: When set to <i>Enabled</i>, you must reboot for the Intel Boot Agent device to be available in the Boot Device menu.</p>
USB Boot	<ul style="list-style-type: none"> Disabled Enabled (default) 	Disables/enables booting to USB boot devices.
Boot Device Priority	Select to display submenu	Specifies the boot sequence from the available types of boot devices.
Hard Disk Drives	Select to display submenu	Specifies the boot sequence from the available hard disk drives.
Removable Devices	Select to display submenu	Specifies the boot sequence from the available removable devices.
ATAPI CD-ROM Drives	Select to display submenu	Specifies the boot sequence from the available ATAPI CD-ROM drives.

4.7.1 Boot Device Priority Submenu

To access this menu, select Boot on the menu bar and then Boot Devices Priority.

Maintenance	Main	Advanced	Security	Power	Boot	Exit
						Boot Device Priority
						Hard Disk Drives
						Removable Devices
						ATAPI CD-ROM Drives

The submenu represented in Table 58 is for setting boot devices priority.

Table 58. Boot Device Priority Submenu

Feature	Options	Description
1 st Boot Device	<ul style="list-style-type: none"> • Removable Dev. • Hard Drive • ATAPI CD-ROM • Intel® Boot Agent (Note) • Disabled 	<p>Specifies the boot sequence according to the device type. The computer will attempt to boot from up to five devices as specified here. Only one of the devices can be an IDE hard disk drive. To specify boot sequence:</p> <ol style="list-style-type: none"> 1. Select the boot device with <↑> or <↓>. 2. Press <Enter> to set the selection as the intended boot device. <p>The default settings for the first through fourth boot devices are, respectively:</p> <ul style="list-style-type: none"> • Removable Dev. • Hard Drive • ATAPI CD-ROM • Intel Boot Agent
2 nd Boot Device		
3 rd Boot Device		
4 th Boot Device		

Note: The boot device identifier for Intel Boot Agent (IBA) may vary depending on the BIOS release.

4.7.2 Hard Disk Drives Submenu

To access this menu, select Boot on the menu bar and then Hard Disk Drives.

Maintenance	Main	Advanced	Security	Power	Boot	Exit
						Boot Device Priority
						Hard Disk Drives
						Removable Devices
						ATAPI CD-ROM Drives

The submenu represented in Table 59 is for setting hard disk drive priority.

Table 59. Hard Disk Drives Submenu

Feature	Options	Description
1 st Hard Disk Drive (Note)	Dependent on installed hard drives	Specifies the boot sequence from the available hard disk drives. To specify boot sequence: <ol style="list-style-type: none"> Select the boot device with <↑> or <↓>. Press <Enter> to set the selection as the intended boot device.

Note: This boot device submenu appears only if at least one boot device of this type is installed. This list will display up to twelve hard disk drives, the maximum number of hard disk drives supported by the BIOS.

4.7.3 Removable Devices Submenu

To access this menu, select Boot on the menu bar, then Removable Devices.

Maintenance	Main	Advanced	Security	Power	Boot	Exit
						Boot Device Priority
						Hard Disk Drives
						Removable Devices
						ATAPI CD-ROM Drives

The submenu represented in Table 60 is for setting removable device priority.

Table 60. Removable Devices Submenu

Feature	Options	Description
1 st Removable Device (Note)	Dependent on installed removable devices	Specifies the boot sequence from the available removable devices. To specify boot sequence: <ol style="list-style-type: none"> Select the boot device with <↑> or <↓>. Press <Enter> to set the selection as the intended boot device.

Note: This boot device submenu appears only if at least one boot device of this type is installed. This list will display up to four removable devices, the maximum number of removable devices supported by the BIOS.

4.7.4 ATAPI CD-ROM Drives Submenu

To access this menu, select Boot on the menu bar and then ATAPI CD-ROM Drives.

Maintenance	Main	Advanced	Security	Power	Boot	Exit
						Boot Device Priority
						Hard Disk Drives
						Removable Devices
						ATAPI CD-ROM Drives

The submenu represented in Table 61 is for setting ATAPI CD-ROM drive priority.

Table 61. ATAPI CD-ROM Drives Submenu

Feature	Options	Description
1 st ATAPI CDROM (Note)	Dependent on installed ATAPI CD-ROM drives	Specifies the boot sequence from the available ATAPI CD-ROM drives. To specify boot sequence: <ol style="list-style-type: none"> 1. Select the boot device with <↑> or <↓>. 2. Press <Enter> to set the selection as the intended boot device.

Note: This boot device submenu appears only if at least one boot device of this type is installed. This list will display up to four ATAPI CD-ROM drives, the maximum number of ATAPI CD-ROM drives supported by the BIOS.

4.8 Exit Menu

To access this menu, select Exit from the menu bar at the top of the screen.

Maintenance	Main	Advanced	Security	Power	Boot	Exit
-------------	------	----------	----------	-------	------	-------------

The menu represented in Table 62 is for exiting the BIOS Setup program, saving changes, and loading and saving defaults.

Table 62. Exit Menu

Feature	Description
Exit Saving Changes	Exits and saves the changes in CMOS SRAM.
Exit Discarding Changes	Exits without saving any changes made in the BIOS Setup program.
Load Optimal Defaults	Loads the optimal default values for all the Setup options.
Load Custom Defaults	Loads the custom defaults for Setup options.
Save Custom Defaults	Saves the current values as custom defaults. Normally, the BIOS reads the Setup values from flash memory. If this memory is corrupted, the BIOS reads the custom defaults. If no custom defaults are set, the BIOS reads the factory defaults.
Discard Changes	Discards changes without exiting Setup. The option values present when the computer was turned on are used.

5 Error Messages and Beep Codes

What This Chapter Contains

5.1	BIOS Error Messages.....	101
5.2	Port 80h POST Codes.....	103
5.3	Bus Initialization Checkpoints	107
5.4	Speaker.....	108
5.5	BIOS Beep Codes	108

5.1 BIOS Error Messages

Table 63 lists the error messages and provides a brief description of each.

Table 63. BIOS Error Messages

Error Message	Explanation
GA20 Error	An error occurred with Gate A20 when switching to protected mode during the memory test.
Pri Master HDD Error Pri Slave HDD Error Sec Master HDD Error Sec Slave HDD Error	Could not read sector from corresponding drive.
Pri Master Drive - ATAPI Incompatible Pri Slave Drive - ATAPI Incompatible Sec Master Drive - ATAPI Incompatible Sec Slave Drive - ATAPI Incompatible	Corresponding drive in not an ATAPI device. Run Setup to make sure device is selected correctly.
A: Drive Error	No response from diskette drive.
Cache Memory Bad	An error occurred when testing L2 cache. Cache memory may be bad.
CMOS Battery Low	The battery may be losing power. Replace the battery soon.
CMOS Display Type Wrong	The display type is different than what has been stored in CMOS. Check Setup to make sure type is correct.
CMOS Checksum Bad	The CMOS checksum is incorrect. CMOS memory may have been corrupted. Run Setup to reset values.
CMOS Settings Wrong	CMOS values are not the same as the last boot. These values have either been corrupted or the battery has failed.
CMOS Date/Time Not Set	The time and/or date values stored in CMOS are invalid. Run Setup to set correct values.
DMA Error	Error during read/write test of DMA controller.
FDC Failure	Error occurred trying to access diskette drive controller.
HDC Failure	Error occurred trying to access hard disk controller.

continued

Table 63. BIOS Error Messages (continued)

Error Message	Explanation
Checking NVRAM.....	NVRAM is being checked to see if it is valid.
Update OK!	NVRAM was invalid and has been updated.
Updated Failed	NVRAM was invalid but was unable to be updated.
Keyboard Error	Error in the keyboard connection. Make sure keyboard is connected properly.
KB/Interface Error	Keyboard interface test failed.
Memory Size Decreased	Memory size has decreased since the last boot. If no memory was removed then memory may be bad.
Memory Size Increased	Memory size has increased since the last boot. If no memory was added there may be a problem with the system.
Memory Size Changed	Memory size has changed since the last boot. If no memory was added or removed then memory may be bad.
No Boot Device Available	System did not find a device to boot.
Off Board Parity Error	A parity error occurred on an off-board card. This error is followed by an address.
On Board Parity Error	A parity error occurred in onboard memory. This error is followed by an address.
Parity Error	A parity error occurred in onboard memory at an unknown address.
NVRAM/CMOS/PASSWORD cleared by Jumper	NVRAM, CMOS, and passwords have been cleared. The system should be powered down and the jumper removed.
<CTRL_N> Pressed	CMOS is ignored and NVRAM is cleared. User must enter Setup.

5.2 Port 80h POST Codes

During the POST, the BIOS generates diagnostic progress codes (POST-codes) to I/O port 80h. If the POST fails, execution stops and the last POST code generated is left at port 80h. This code is useful for determining the point where an error occurred.

Displaying the POST-codes requires a PCI bus add-in card, often called a POST card. The POST card can decode the port and display the contents on a medium such as a seven-segment display.

NOTE

The POST card must be installed in PCI bus connector 1.

The tables below offer descriptions of the POST codes generated by the BIOS. Table 64 defines the uncompressed INIT code checkpoints, Table 65 describes the boot block recovery code checkpoints, and Table 66 lists the runtime code uncompressed in F000 shadow RAM. Some codes are repeated in the tables because that code applies to more than one operation.

Table 64. Uncompressed INIT Code Checkpoints

Code	Description of POST Operation
D0	NMI is Disabled. Onboard KBC, RTC enabled (if present). Init code Checksum verification starting.
D1	Keyboard controller BAT test, CPU ID saved, and going to 4 GB flat mode.
D3	Do necessary chipset initialization, start memory refresh, and do memory sizing.
D4	Verify base memory.
D5	Init code to be copied to segment 0 and control to be transferred to segment 0.
D6	Control is in segment 0. To check recovery mode and verify main BIOS checksum. If either it is recovery mode or main BIOS checksum is bad, go to check point E0 for recovery else go to check point D7 for giving control to main BIOS.
D7	Find Main BIOS module in ROM image.
D8	Uncompress the main BIOS module.
D9	Copy main BIOS image to F000 shadow RAM and give control to main BIOS in F000 shadow RAM.

Table 65. Boot Block Recovery Code Checkpoints

Code	Description of POST Operation
E0	Onboard Floppy Controller (if any) is initialized. Compressed recovery code is uncompressed in F000:0000 in Shadow RAM and give control to recovery code in F000 Shadow RAM. Initialize interrupt vector tables, initialize system timer, initialize DMA controller and interrupt controller.
E8	Initialize extra (Intel Recovery) Module.
E9	Initialize floppy drive.
EA	Try to boot from floppy. If reading of boot sector is successful, give control to boot sector code.
EB	Bootting from floppy failed, look for ATAPI (LS-120, Zip) devices.
EC	Try to boot from ATAPI. If reading of boot sector is successful, give control to boot sector code.
EF	Bootting from floppy and ATAPI device failed. Give two beeps. Retry the bootting procedure again (go to check point E9).

Table 66. Runtime Code Uncompressed in F000 Shadow RAM

Code	Description of POST Operation
03	NMI is Disabled. To check soft reset/power-on.
05	BIOS stack set. Going to disable cache if any.
06	POST code to be uncompressed.
07	CPU init and CPU data area init to be done.
08	CMOS checksum calculation to be done next.
0B	Any initialization before keyboard BAT to be done next.
0C	KB controller I/B free. To issue the BAT command to keyboard controller.
0E	Any initialization after KB controller BAT to be done next.
0F	Keyboard command byte to be written.
10	Going to issue Pin-23,24 blocking/unblocking command.
11	Going to check pressing of <INS>, <END> key during power-on.
12	To init CMOS if "Init CMOS in every boot" is set or <END> key is pressed. Going to disable DMA and Interrupt controllers.
13	Video display is disabled and port-B is initialized. Chipset init about to begin.
14	8254 timer test about to start.
19	About to start memory refresh test.
1A	Memory Refresh line is toggling. Going to check 15 μ s ON/OFF time.
23	To read 8042 input port and disable Megakey GreenPC feature. Make BIOS code segment writeable.
24	To do any setup before Int vector init.
25	Interrupt vector initialization to begin. To clear password if necessary.
27	Any initialization before setting video mode to be done.
28	Going for monochrome mode and color mode setting.
2A	Different buses init (system, static, output devices) to start if present. (See Section 5.3 for details of different buses.)
2B	To give control for any setup required before optional video ROM check.
2C	To look for optional video ROM and give control.
2D	To give control to do any processing after video ROM returns control.
2E	If EGA/VGA not found then do display memory R/W test.
2F	EGA/VGA not found. Display memory R/W test about to begin.
30	Display memory R/W test passed. About to look for the retrace checking.
31	Display memory R/W test or retrace checking failed. To do alternate Display memory R/W test.
32	Alternate Display memory R/W test passed. To look for the alternate display retrace checking.
34	Video display checking over. Display mode to be set next.
37	Display mode set. Going to display the power-on message.
38	Different buses init (input, IPL, general devices) to start if present. (See Section 5.3 for details of different buses.)
39	Display different buses initialization error messages. (See Section 5.3 for details of different buses.)
3A	New cursor position read and saved. To display the Hit message.

continued

Table 66. Runtime Code Uncompressed in F000 Shadow RAM (continued)

Code	Description of POST Operation
40	To prepare the descriptor tables.
42	To enter in virtual mode for memory test.
43	To enable interrupts for diagnostics mode.
44	To initialize data to check memory wrap around at 0:0.
45	Data initialized. Going to check for memory wrap around at 0:0 and finding the total system memory size.
46	Memory wrap around test done. Memory size calculation over. About to go for writing patterns to test memory.
47	Pattern to be tested written in extended memory. Going to write patterns in base 640k memory.
48	Patterns written in base memory. Going to find out amount of memory below 1M memory.
49	Amount of memory below 1M found and verified. Going to find out amount of memory above 1M memory.
4B	Amount of memory above 1M found and verified. Check for soft reset and going to clear memory below 1M for soft reset. (If power on, go to check point # 4Eh).
4C	Memory below 1M cleared. (SOFT RESET) Going to clear memory above 1M.
4D	Memory above 1M cleared. (SOFT RESET) Going to save the memory size. (Go to check point # 52h).
4E	Memory test started. (NOT SOFT RESET) About to display the first 64k memory size.
4F	Memory size display started. This will be updated during memory test. Going for sequential and random memory test.
50	Memory testing/initialization below 1M complete. Going to adjust displayed memory size for relocation/shadow.
51	Memory size display adjusted due to relocation/ shadow. Memory test above 1M to follow.
52	Memory testing/initialization above 1M complete. Going to save memory size information.
53	Memory size information is saved. CPU registers are saved. Going to enter in real mode.
54	Shutdown successful, CPU in real mode. Going to disable gate A20 line and disable parity/NMI.
57	A20 address line, parity/NMI disable successful. Going to adjust memory size depending on relocation/shadow.
58	Memory size adjusted for relocation/shadow. Going to clear Hit message.
59	Hit message cleared. <WAIT...> message displayed. About to start DMA and interrupt controller test.
60	DMA page register test passed. To do DMA#1 base register test.
62	DMA#1 base register test passed. To do DMA#2 base register test.
65	DMA#2 base register test passed. To program DMA unit 1 and 2.
66	DMA unit 1 and 2 programming over. To initialize 8259 interrupt controller.
7F	Extended NMI sources enabling is in progress.
80	Keyboard test started. Clearing output buffer, checking for stuck key, to issue keyboard reset command.
81	Keyboard reset error/stuck key found. To issue keyboard controller interface test command.
82	Keyboard controller interface test over. To write command byte and init circular buffer.
83	Command byte written, global data init done. To check for lock-key.

continued

Table 66. Runtime Code Uncompressed in F000 Shadow RAM (continued)

Code	Description of POST Operation
84	Lock-key checking over. To check for memory size mismatch with CMOS.
85	Memory size check done. To display soft error and check for password or bypass setup.
86	Password checked. About to do programming before setup.
87	Programming before setup complete. To uncompress SETUP code and execute CMOS setup.
88	Returned from CMOS setup program and screen is cleared. About to do programming after setup.
89	Programming after setup complete. Going to display power-on screen message.
8B	First screen message displayed. <WAIT...> message displayed. PS/2 Mouse check and extended BIOS data area allocation to be done.
8C	Setup options programming after CMOS setup about to start.
8D	Going for hard disk controller reset.
8F	Hard disk controller reset done. Floppy setup to be done next.
91	Floppy setup complete. Hard disk setup to be done next.
95	Init of different buses optional ROMs from C800 to start. (See Section 5.3 for details of different buses.)
96	Going to do any init before C800 optional ROM control.
97	Any init before C800 optional ROM control is over. Optional ROM check and control will be done next.
98	Optional ROM control is done. About to give control to do any required processing after optional ROM returns control and enable external cache.
99	Any initialization required after optional ROM test over. Going to setup timer data area and printer base address.
9A	Return after setting timer and printer base address. Going to set the RS-232 base address.
9B	Returned after RS-232 base address. Going to do any initialization before Coprocessor test.
9C	Required initialization before Coprocessor is over. Going to initialize the Coprocessor next.
9D	Coprocessor initialized. Going to do any initialization after Coprocessor test.
9E	Initialization after Coprocessor test is complete. Going to check extended keyboard, keyboard ID and num-lock.
A2	Going to display any soft errors.
A3	Soft error display complete. Going to set keyboard typematic rate.
A4	Keyboard typematic rate set. To program memory wait states.
A5	Going to enable parity/NMI.
A7	NMI and parity enabled. Going to do any initialization required before giving control to optional ROM at E000.
A8	Initialization before E000 ROM control over. E000 ROM to get control next.
A9	Returned from E000 ROM control. Going to do any initialization required after E000 optional ROM control.
AA	Initialization after E000 optional ROM control is over. Going to display the system configuration.
AB	Put INT13 module runtime image to shadow.
AC	Generate MP for multiprocessor support (if present).
AD	Put CGA INT10 module (if present) in Shadow.

continued

Table 66. Runtime Code Uncompressed in F000 Shadow RAM (continued)

Code	Description of POST Operation
AE	Uncompress SMBIOS module and init SMBIOS code and form the runtime SMBIOS image in shadow.
B1	Going to copy any code to specific area.
00	Copying of code to specific area done. Going to give control to INT-19 boot loader.

5.3 Bus Initialization Checkpoints

The system BIOS gives control to the different buses at several checkpoints to do various tasks. Table 67 describes the bus initialization checkpoints.

Table 67. Bus Initialization Checkpoints

Checkpoint	Description
2A	Different buses init (system, static, and output devices) to start if present.
38	Different buses init (input, IPL, and general devices) to start if present.
39	Display different buses initialization error messages.
95	Init of different buses optional ROMs from C800 to start.

While control is inside the different bus routines, additional checkpoints are output to port 80h as WORD to identify the routines under execution. In these WORD checkpoints, the low byte of the checkpoint is the system BIOS checkpoint from which the control is passed to the different bus routines. The high byte of the checkpoint is the indication of which routine is being executed in the different buses. Table 68 describes the upper nibble of the high byte and indicates the function that is being executed.

Table 68. Upper Nibble High Byte Functions

Value	Description
0	func#0, disable all devices on the bus concerned.
1	func#1, static devices init on the bus concerned.
2	func#2, output device init on the bus concerned.
3	func#3, input device init on the bus concerned.
4	func#4, IPL device init on the bus concerned.
5	func#5, general device init on the bus concerned.
6	func#6, error reporting for the bus concerned.
7	func#7, add-on ROM init for all buses.

Table 69 describes the lower nibble of the high byte and indicates the bus on which the routines are being executed.

Table 69. Lower Nibble High Byte Functions

Value	Description
0	Generic DIM (Device Initialization Manager)
1	On-board System devices
2	ISA devices
3	EISA devices
4	ISA PnP devices
5	PCI devices

5.4 Speaker

A 47 Ω inductive speaker is mounted on the Desktop Board D865PCD. The speaker provides audible error code (beep code) information during POST.

For information about	Refer to
The location of the onboard speaker on the Desktop Board D865PCD	Figure 1, on page 13

5.5 BIOS Beep Codes

Whenever a recoverable error occurs during POST, the BIOS displays an error message describing the problem (see Table 70). The BIOS also issues a beep code (one long tone followed by two short tones) during POST if the video configuration fails (a faulty video card or no card installed) or if an external ROM module does not properly checksum to zero.

An external ROM module (for example, a video BIOS) can also issue audible errors, usually consisting of one long tone followed by a series of short tones. For more information on the beep codes issued, check the documentation for that external device.

There are several POST routines that issue a POST terminal error and shut down the system if they fail. Before shutting down the system, the terminal-error handler issues a beep code signifying the test point error, writes the error to I/O port 80h, attempts to initialize the video and writes the error in the upper left corner of the screen (using both monochrome and color adapters).

If POST completes normally, the BIOS issues one short beep before passing control to the operating system.

Table 70. Beep Codes

Beep	Description
1	Memory error
3	Memory error
6	System failure
7	System failure
8	Video error

